

# INSTRUCTION MANUAL

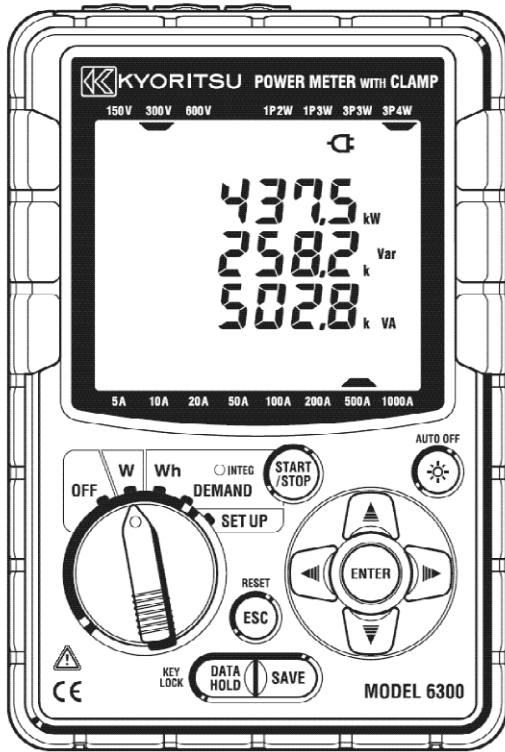

## DIGITAL POWER METER

# MODEL 6300



KYORITSU ELECTRICAL INSTRUMENTS WORKS, LTD.,  
TOKYO, JAPAN

<b>Contents</b> .....	1
<b>Unpacking Procedure</b> .....	4
<b>Safety warnings</b> .....	6
<b>Section 1 Instrument overview</b> .....	<b>1.1</b>
1-1 Features .....	1.1
1-2 Functional overview .....	1.3
1-3 Measurement procedures .....	1.4
1-4 Outline of maximum demand measurement concept .....	1.5
<b>Section 2 Instrument layout</b> .....	<b>2.1</b>
2-1 Display & keys .....	2.1
2-2 Connector .....	2.5
2-3 CF card/ USB part .....	2.6
<b>Section 3 Preparation for measurement</b> .....	<b>3.1</b>
3-1 Power cord connection .....	3.1
3-2 Voltage test leads and Clamp sensor connection .....	3.2
3-3 Turning on the instrument .....	3.4
3-3-1 Start-up screen .....	3.4
3-3-2 Error message .....	3.5
3-3-3 Battery Operation .....	3.6
<b>Section 4 Setting</b> .....	<b>4.1</b>
4-1 List of setting items .....	4.2
4-2 Classification of setting items .....	4.3
4-3 Setting procedure of each setting item .....	4.4
4-3-1 "Setting 01" Wiring .....	4.5
4-3-2 "Setting 02" Voltage range .....	4.6
4-3-3 "Setting 03" Current range .....	4.7
4-3-4 "Setting 04" Clamp sensor .....	4.8
4-3-5 "Setting 05" VT ratio .....	4.9
4-3-6 "Setting 06" CT ratio .....	4.10
4-3-7 "Setting 07" Time .....	4.11
4-3-8 "Setting 08" Buzzer .....	4.12
4-3-9 "Setting 09" Integration interval .....	4.13
4-3-10 "Setting 10" Integration start time and date .....	4.14
4-3-11 "Setting 11" Integration stop time and date .....	4.15
4-3-12 "Setting 12" Reset of integration value .....	4.16
4-3-13 "Setting 13" Demand Interval .....	4.17
4-3-14 "Setting 14" Demand start time and date .....	4.18
4-3-15 "Setting 15" Demand stop time and date .....	4.19
4-3-16 "Setting 16" Demand target value .....	4.20
4-3-17 "Setting 17" Demand inspection cycle .....	4.21
4-3-18 "Setting 18" Reset of demand value .....	4.22
4-3-19 "Setting 19" Use of CF card .....	4.23

4-3-20	"Setting 20" Formatting CF card .....	4.24
4-3-21	"Setting 21" Deleting the data in CF card .....	4.26
4-3-22	"Setting 22" Deleting the data in Internal memory .....	4.27
4-3-23	"Setting 23" System reset .....	4.28
4-3-24	"Setting 24" Loading settings .....	4.29
4-3-25	"Setting 25" Saving settings .....	4.30
<b>Section 5</b>	<b>Wiring configurations .....</b>	<b>5.1</b>
5-1	Important Preliminary checks .....	5.1
5-2	Basic wiring configuration .....	5.2
5-3	Using supplementary VT/ CT's .....	5.4
<b>Section 6</b>	<b>Instantaneous value measurement .....</b>	<b>6.1</b>
6-1	Wiring Configuration display screen.....	6.4
6-2	Selecting/changing the display screen .....	6.6
6-3	Customizing the display .....	6.9
6-4	Saving data .....	6.12
6-4-1	Saving Procedure .....	6.12
6-4-2	Limitation of saving .....	6.14
6-4-3	Save data .....	6.15
6-5	Digit / Over-range indication .....	6.17
6-5-1	Digits.....	6.17
6-5-2	Over-range indication / Bar indication .....	6.19
<b>Section 7</b>	<b>Integration value measurement .....</b>	<b>7.1</b>
7-1	How to start measurement .....	7.4
7-2	How to stop measurement.....	7.7
7-3	Resetting the integration value .....	7.9
7-4	Switching displays .....	7.10
7-5	Saving data .....	7.12
7-5-1	How to save .....	7.12
7-5-2	Limitation of saving .....	7.13
7-5-3	Save data .....	7.15
7-6	Digits / Over-range indication .....	7.17
<b>Section 8</b>	<b>Demand value measurement .....</b>	<b>8.1</b>
8-1	Demand measurement .....	8.4
8-2	Displayed items and how to switch .....	8.7
8-3	How to start measurement .....	8.9
8-4	How to stop measurement .....	8.12
8-5	Resetting the demand value .....	8.14
8-6	Saving data .....	8.15
8-6-1	Saving .....	8.15
8-6-2	Limitation of saving .....	8.16
8-6-3	Save data .....	8.18
8-7	Digits / Over-range indication .....	8.20

<b>Section 9</b>	<b>CF card/ Internal memory</b> .....	<b>9.1</b>
9-1	Instrument and CF card/ Internal memory .....	9.1
9-2	Inserting / removing the CF card .....	9.3
9-3	Formatting or saving data in CF card/ Internal memory .....	9.4
<b>Section 10</b>	<b>Communication function/ Interface software</b> ....	<b>10.1</b>
10-1	Software Installation (KEW POWER PLUS) .....	10.2
10-2	USB driver installation .....	10.4
10-3	Starting "KEW POWER PLUS" .....	10.6
10-4	Connecting the instrument to the PC .....	10.7
10-5	Download to PC .....	10.8
10-6	Set up via PC .....	10.10
10-7	USB driver un-installation .....	10.12
<b>Section 11</b>	<b>Other functions</b> .....	<b>11.1</b>
<b>Section 12</b>	<b>Troubleshooting</b> .....	<b>12.1</b>
12-1	General Trouble-shooting .....	12.1
12-2	Battery replacement .....	12.3
<b>Section 13</b>	<b>Specification</b> .....	<b>13.1</b>
13-1	General specification .....	13.1
13-2	Instantaneous value measurement .....	13.3
13-3	Integration value measurement .....	13.5
13-4	Demand value measurement .....	13.6
13-5	Other specifications .....	13.7
13-6	Clamp sensor Specifications .....	13.8

## Unpacking Procedure

We thank you for purchasing the Digital Power Meter "MODEL6300".

Please check the contents and instrument before use.

- Items listed below are included with the standard set:

1	Main unit	MODEL6300 :1 unit
2	Voltage test lead	MODEL7141: 1 set (red, black, green, blue: 1pce for each)
3	Power cord	MODEL7170: 1pce
4	USB cord	MODEL7148: 1pce
5	Quick manual	1pce
6	CD-ROM	1pce
7	Battery	Alkaline size AA battery LR6: 6pcs
8	Compact flash card	32MB: 1 pce
9	Card Reader	MODEL 8319
10	Carrying case	MODEL9125: 1pce

### Optional parts

11	Clamp sensor	Depending on model purchased
12	Instruction manual for clamp sensor	1pce for each clamp sensor
13	Compact flash card	32 / 64 / 128 MB
14	Carrying case for Main unit	MODEL9132

1. Main unit

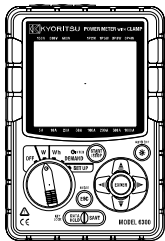

2. Voltage test leads

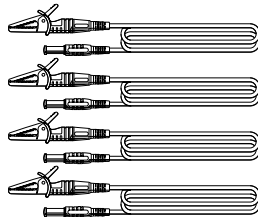

3. Power cord



4. USB cord

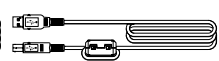

10. Carrying case

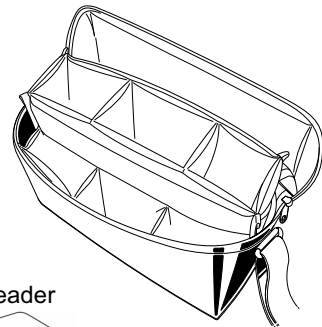

5. Quick manual

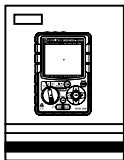

6. CD-ROM



7. Batteries



8. Compact flash card

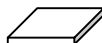

9. Card Reader



**Optional parts**

**11. Clamp sensor**

(Depending on model purchased)

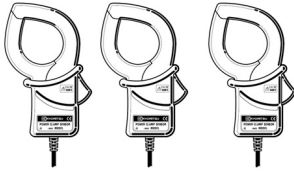

1000A type( $\phi$ 68mm)	M-8124
500A type ( $\phi$ 40mm)	M-8125
200A type ( $\phi$ 40mm)	M-8126
100A type ( $\phi$ 24mm)	M-8127
50A type ( $\phi$ 24mm)	M-8128

**12. Instruction manual for clamp sensor**

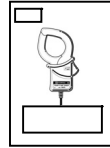

**13. Compact flash card**



32MB	M-8305
64MB	M-8306
128MB	M-8307

**14. Carrying case for Main unit**

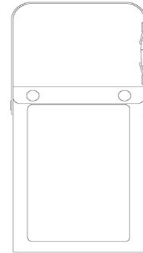

• **Storage**

Store the items as shown below after use.

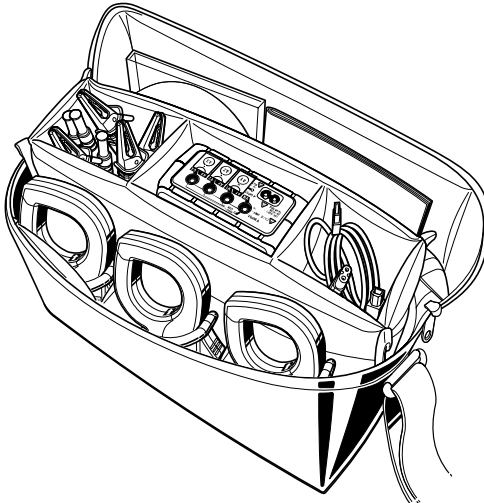

• In case any of the items listed above are found to be damaged or missing or if the printing is unclear, please contact your local KYORITSU distributor from where the instrument was purchased.

## Safety warnings



This instrument has been designed, manufactured and tested according to IEC 61010: Safety requirements for Electronic Measuring apparatus, and delivered in the best condition after passing quality control tests .

**This instruction manual contains warnings and safety rules which have to be observed by the user to ensure safe operation of the instrument and to maintain it in safe condition. Therefore, read through these operating instructions before using the instrument.**

### **WARNING**

- Read through and understand the instructions contained in this manual before using the instrument.
- Keep the manual at hand to enable quick reference whenever necessary.
- The instrument is to be used only in its intended applications.
- Understand and follow all the safety instructions contained in the manual.
- Read the enclosed Quick manual after reading this instruction manual.
- As to the Clamp sensor use, refer to the instruction manual supplied with the sensor.

It is essential that the above instructions are adhered to. Failure to follow the above instructions may cause injury, instrument damage and/or damage to equipment under test.

The symbol  indicated on the instrument, means that the user must refer to the related parts in the manual for safe operation of the instrument. It is essential to read the instructions wherever the  symbol appears in the manual.

 **DANGER** is reserved for conditions and actions that are likely to cause serious or fatal injury.

 **WARNING** is reserved for conditions and actions that can cause serious or fatal injury.

 **CAUTION** is reserved for conditions and actions that can cause injury or instrument damage.

### **DANGER**

- Never make measurement on a circuit in which the electrical potential exceeds AC600V.
- Do not attempt to make measurement in the presence of flammable gasses. Otherwise, the use of the instrument may cause sparking, which can lead to an explosion.
- Never attempt to use the instrument if its surface or your hand are wet.
- Do not exceed the maximum allowable input of any measuring range.
- Never open the Battery cover and CF card connector cover during a measurement.
- Verify proper operation on a known source before use or taking action as a result of the indication of the instrument.

**⚠ WARNING**





- Never attempt to make any measurement if any abnormal conditions, such as a broken cover or exposed metal parts are present on the Instrument, Voltage test leads, Power cord and Clamp sensor.
- Ensure that the Current input terminal cover, USB connector cover and CF card connector cover are closed when not in use during a measurement. Ensure that the CF card connector cover screw is tightened.
- Do not install substitute parts or make any modification to the instrument. Return the instrument to your local KYORITSU distributor for repair or re-calibration in case of suspected faulty operation.
- Ensure that the Power cord, Voltage test leads and Clamp sensor are firmly inserted into the terminal.
- Do not try to replace the batteries if the surface of the instrument is wet.
- Ensure that the Power cord, Voltage test leads and Clamp sensor are removed from the instrument, and that the instrument is switched off when opening the Battery cover for battery replacement.

**⚠ CAUTION**

- Always set the Function switch to the appropriate position before making measurement.
- Set the Function switch to the “OFF” position after use and remove the Power cord, Voltage test leads and Clamp sensors. Remove the batteries if the instrument is to be stored and will not be in use for a long period.
- Do not expose the instrument to direct sunlight, high temperatures, humidity or dew.
- Use a damp cloth with neutral detergent for cleaning the instrument. Do not use abrasives or solvents.
- Do not store the instrument if it is wet.

Carefully read and follow the instructions: **⚠ DANGER**, **⚠ WARNING**, **⚠ CAUTION** and **NOTE**, described in each section.

**The following symbols are used in this manual:**

	User must refer to the explanations in the instruction manual.
	Instrument with double or reinforced insulation, Class II insulation
	AC
	(Functional) Earth terminal



## 1. Instrument overview

This section is an overview of instrument features and functions. This instrument is a power clamp meter, and can be used for various wiring systems. For example, in a single-phase 2-wire circuit, this instrument can measure up to 3 different loads.

The instrument can measure fundamental electric power factors, namely, instantaneous values and integration values. Demand measurement, which is vital for energy surveys, is also available. Each data point can be saved to a CF (compact flash) card or transferred to a PC via a USB connection.

### 1-1 Features

- Safety design

Designed to international safety standard IEC61010.

- Wiring

This instrument supports:

single-phase 2-wire (1ch), single-phase 2-wire (2ch), single-phase 2-wire (3ch), single-phase 3-wire, three-phase 3-wire, three-phase 4-wire.

- Measurement and calculation

The MODEL6300 measures and calculates:

voltage(RMS), current(RMS), active/ reactive/ apparent power, power factor, frequency, current flowing on the neutral line(only for three-phase 4-wire) active/ reactive/ apparent electrical energy.

- Demand measurement

Electricity consumption can be easily monitored so as not to exceed target maximum demand values.

- Saving the measured data

Instantaneous values can be saved whenever the  key is pressed.

The integration value and demand value can be saved in wide cycle from 1 sec. to 1 hour.

In addition, max and average instantaneous values can be measured at Integration/ demand measurement cycles.

- **Power supply**  
This instrument operates either with AC power supply or batteries.  
In the event of service interruption while the instrument is operating with AC power supply, power to the instrument is automatically restored by the battery set in the instrument.  
Batteries can also be used for backing up data.
- **Large display**  
Any three measurement parameters can be displayed simultaneously.  
(e.g. Current, Active power, Power factor)
- **Customizing the display**  
The three displayed parameters can be changed by customizing the display screen.
- **Backlight**  
A backlight function permits viewing the test results in dimly lit areas.
- **Clamp sensor type**  
The instrument takes a wide range of user-friendly clamps.
- **Compact design**  
Light weight and portable.
- **User friendly set up**  
The setting up of the instrument is relatively easy.

1-2 Functional overview

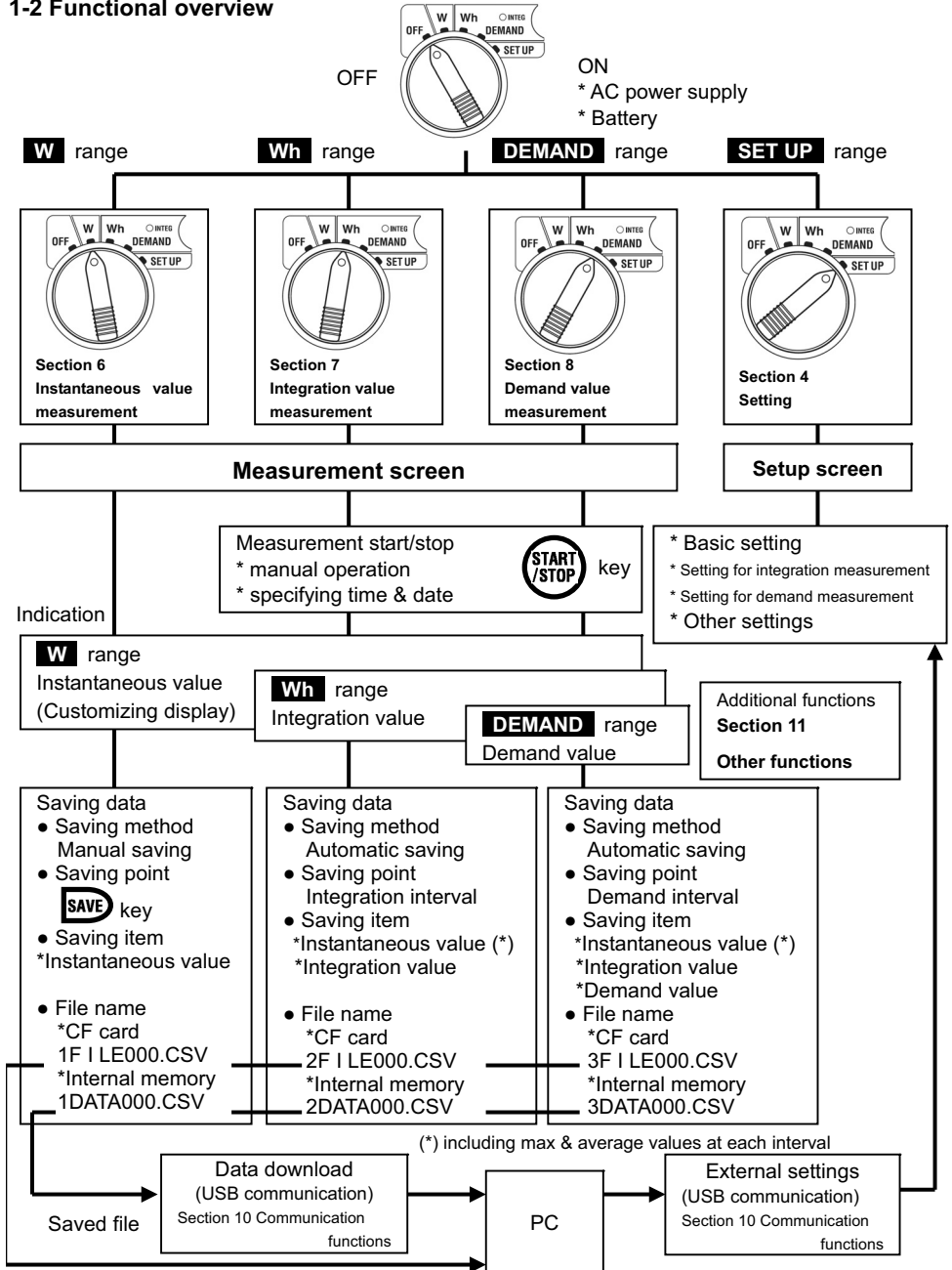

### 1-3 Measurement procedures

- Measurement flow charts

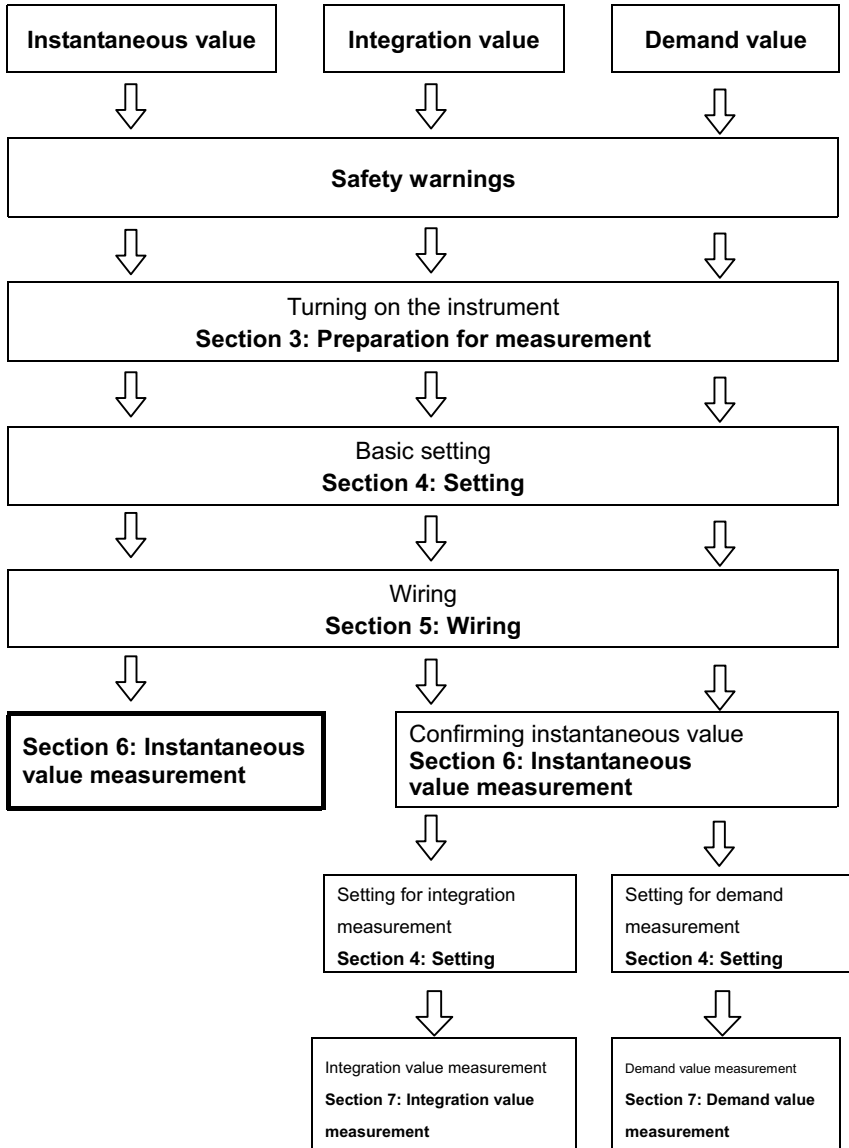

#### 1-4 Outline of maximum demand measurement concept

In some countries, large consumers of electricity will usually have a maximum demand contract with the power company. Such contract varies from country to country. The following is an explanation of a typical Japanese maximum demand contract.

- Maximum Demand contract

In such a contract the electricity tariff rates (i.e. for kWhr units) are based upon the consumer's maximum power demand. The maximum demand is the maximum of average powers recorded over a 30min intervals. This is measured by the maximum demand meter belonging to the power company.

Let's assume that a power company has the following applicable rates.

\$2 per kWhr unit for a recorded max demand 300KW during a year

\$4 per kWhr unit for a recorded max demand 500KW during a year

\$5 per kWhr unit for a recorded max demand 600KW during a year

Assuming that the consumer is on the 500kW/year rate (ie. \$4), and the recorded max demand during a particular day(say 15<sup>th</sup> January) is 600kW . Then the new applicable rate from 1<sup>st</sup> February onwards will be the 600kW/year rate (ie. \$5) for the next 365 days. If a year later, on February 1<sup>st</sup> the recorded maximum demand is 300kW, then the new applicable rates will be changed to 300kW/year rate (i.e. \$2) for the subsequent 365 days. However if during this period, the max demand goes up again, and say 600kW is recorded on 15<sup>th</sup> March, the applicable rates change again to the 600kW/year rate (i.e.\$5) for the subsequent 365 days.

- Benefits of maximum demand control

It is thus important for consumers with such contracts to monitor closely fluctuations in their power demand to ensure that their max demand limits are not exceeded and thus incur higher tariffs. Maximum Demand control is more effective in countries with higher electricity tariffs.

- Status of maximum demand contract

In the past, in Japan, only consumers whose electricity supply was rated at 600kW or more used to enter into a demand contract. However, nowadays power companies install maximum demand meters at all consumers whose supply is rated 70kW or more.

- Maximum Demand measurement limitations

N.B. The readings from power company maximum demand meter and from the 6300 will not match completely due to an obvious time-lag difference in the start of the integration period (eg.30mins) over which the max demand is taken.

## 2. Instrument layout

### 2-1 Display & keys

- Front view

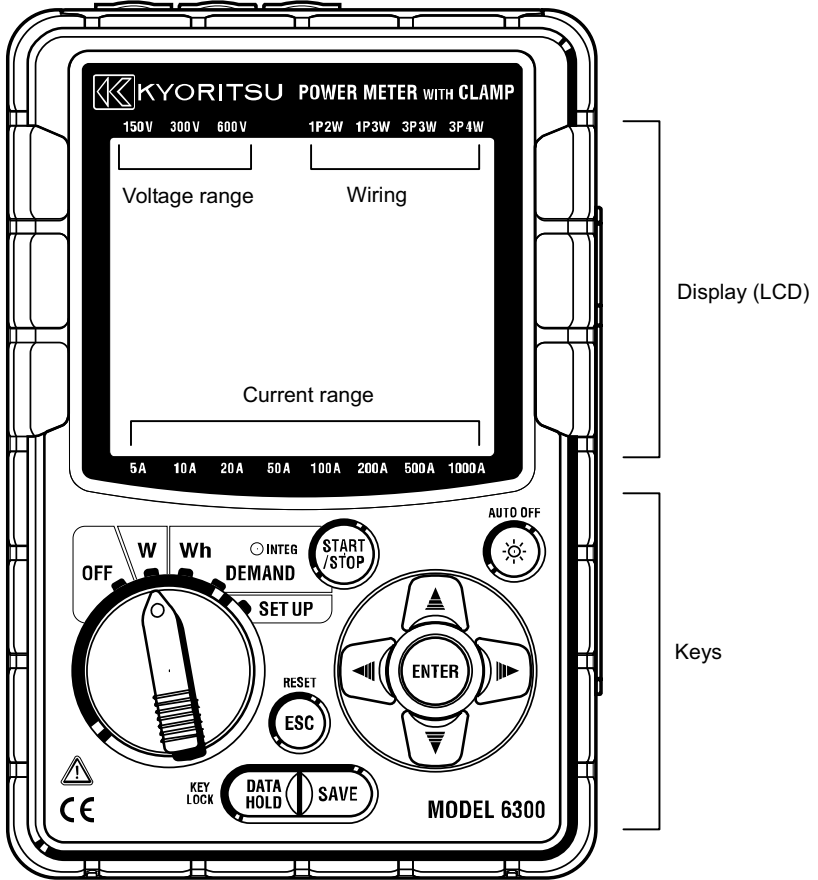

• Key operations

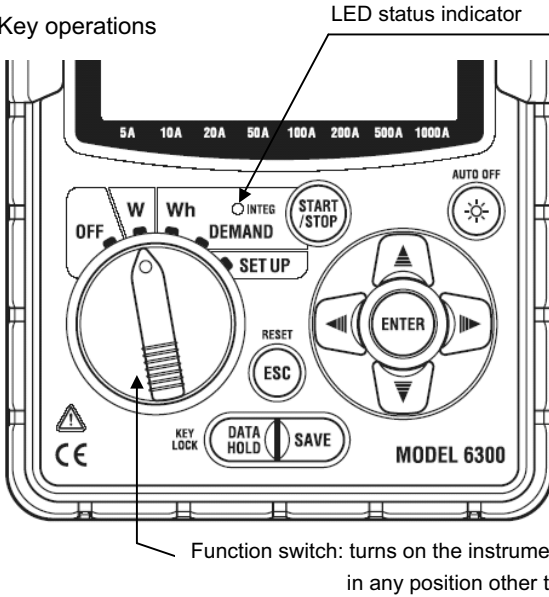

LED lights up:  
During integration/  
Max demand measurement  
LED flashes:  
During integration/  
demand stand-by mode

Function switch: turns on the instrument when it is in any position other than OFF.

Keys		Details
	<b>START/STOP</b> key	Starts/ Stops integration or demand measurement.
	<b>BACKLIGHT</b> key	Switches on/off the backlight of the LCD.
	<b>Cursor</b> key	Measurement screen: Switches the display contents. Setting screen: Changes selection, number, or moves digits.
	<b>ENTER</b> key	Confirms entry such as a change to a setting.
	<b>ESC</b> key	* Cancels a setting * Clears integration/ demand value
	<b>DATA HOLD</b> key	* Data hold * Key lock Pressing this key for at least 2 sec. locks keys. Pressing again this key for at least 2 sec. releases key lock.
	<b>SAVE</b> key	Saves the instantaneous measurement data.





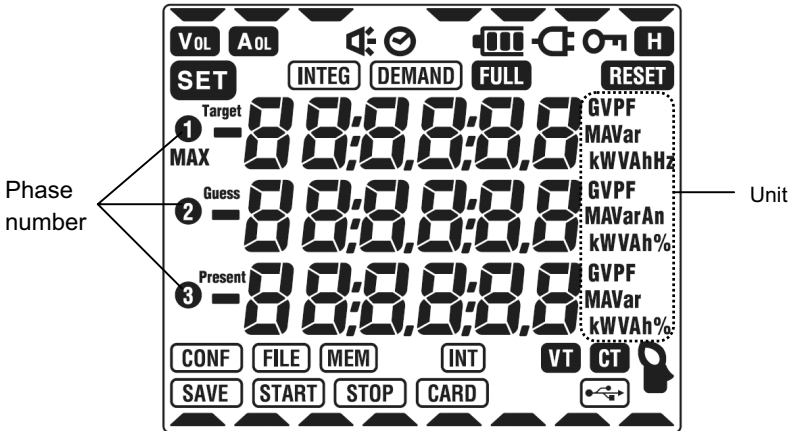

- All Marks displayed on the LCD



< Marks indicate the measurement status or functions >

	Displayed when the keys are locked.
	Displayed when voltage exceeds a certain value.
	Displayed when current exceeds a certain value.
	Displayed when instrument is operating with AC power supply.
	Displayed when instrument if operating with batteries.
	Displayed when data hold function is activated.
	Displayed during integration, Flashes during stand-by mode.
	Displayed during demand, Flashes during stand-by mode.
	Displayed when the capacity of CF card or internal memory is full.
	Displayed while saving data in CF card.
	Displayed when opening/ closing a file at measurement.
	Displayed when saving data.
	Displayed when a file exists in the internal memory.
	Displayed when VT ratio is set to at a value other than 1.
	Displayed when CT ratio is set to at a value other than 1.



<Setting screen: Marks displayed on **SET UP** range depending on each setting.>

<b>SET</b>	Displayed on every setting screen.
	“Setting 04” Clamp sensor
<b>VT</b>	“Setting 05” VT ratio
<b>CT</b>	“Setting 06” CT ratio
	“Setting 07” Time
	“Setting 08” Buzzer
<b>INTEG</b> <b>INT</b>	“Setting 09” Integration interval
<b>INTEG</b> <b>START</b>	“Setting 10” Integration start time & date
<b>INTEG</b> <b>STOP</b>	“Setting 11” Integration stop time & date
<b>INTEG</b> <b>RESET</b>	“Setting 12” Reset of Integration value
<b>DEMAND</b> <b>INT</b>	“Setting 13” Demand interval
<b>DEMAND</b> <b>START</b>	“Setting 14” Demand start time & date
<b>DEMAND</b> <b>STOP</b>	“Setting 15” Demand stop time & date
<b>DEMAND</b> <b>Target</b>	“Setting 16” Demand target value
<b>DEMAND</b> 	“Setting 17” Demand inspection cycle
<b>DEMAND</b> <b>RESET</b>	“Setting 18” Reset of Demand value
<b>CARD</b>	“Setting 19” Use of CF card “Setting 20” Formatting CF card “Setting 21” Deleting the data in CF card
<b>MEM</b>	“Setting 22” Deleting the data in internal memory
<b>RESET</b>	“Setting 23” System reset
<b>CONF</b>	“Setting 24” Loading settings “Setting 25” Saving settings

< Marks indicate measurement/ setting items on **DEMAND** range.>

<b>Target</b>	Demand target value
<b>Guess</b>	Demand predicted value
<b>Present</b>	Present demand value
<b>MAX</b>	Max demand value, and the time and date when it was recorded.

< Other marks>

	Indicates the selected wiring, voltage range and current range
	Displayed during data communication via USB.

## 2-2 Connector

- Descriptions

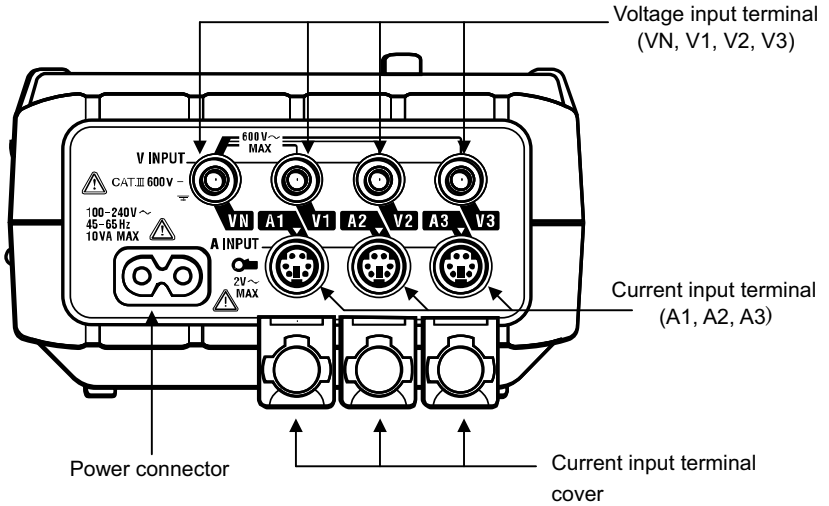

- Terminals used for measuring each wiring

Wiring	Voltage input terminal	Current input terminal
Single-phase 2-wire (1ch) "1P2W(1ch)"	VN-V1	A1
Single-phase 2-wire (2ch) "1P2W(2ch)"	VN-V1	A1, A2
Single-phase 2-wire (3ch) "1P2W(3ch)"	VN-V1	A1, A2, A3
Single-phase 3-wire "1P3W"	VN-V1, VN-V2	A1, A2
Three-phase 3-wire "3P3W"	VN-V1, VN-V2	A1, A2
Three-phase 4-wire "3P4W"	VN-V1, VN-V2, VN-V3	A1, A2, A3

### 2-3 CF card/ USB part

- Descriptions

<When the cover is closed>

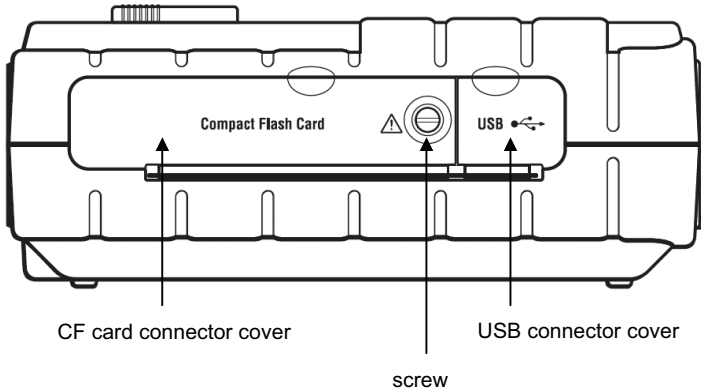

<When the cover is opened>

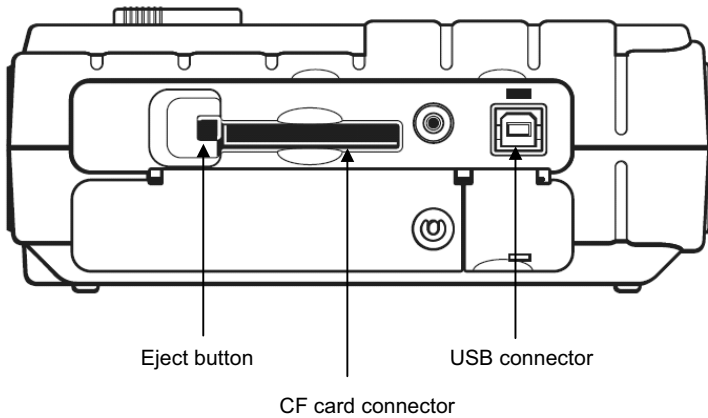

### 3. Preparation for measurement

This section explains the setting up of the instrument.

#### 3-1 Power cord connection

- Check the following before connecting the Power cord.

#### **⚠ DANGER**

- Use only the Power cord supplied with this instrument.
- Connect the Power cord mains plug to a mains socket outlet. The mains supply voltage must not exceed 240V.

#### **⚠ WARNING**

- Confirm that the Function switch on the instrument is in the OFF position, and then connect the Power cord.
- Connect the Power cord to the instrument first. Cord to be firmly inserted.
- Never attempt to make measurement if any abnormal conditions are noted, such as a broken cover and exposed metal parts.
- When the instrument is not in use, disconnect the Power cord from the outlet.
- When unplugging the cord from the mains socket outlet, do so by removing the plug first and not by pulling the power cord.

- Power cord connection

Follow the procedure below, and connect the Power cord.

- (1) Confirm that the Function switch on the instrument is in the OFF position.
- (2) Connect the Power cord to the Power connector on the instrument.
- (3) Connect the Power cord plug to a mains socket outlet.

- Power supply rating

Rated supply voltage: 100 ~ 240VAC  
(±10%)

Rated power supply frequency: 45 ~ 65Hz

Max power consumption: 10VA max

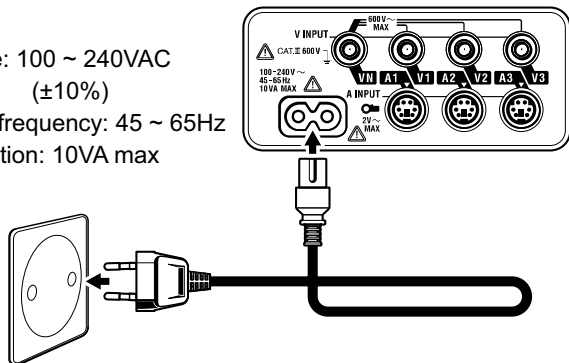

### 3-2 Voltage test leads and Clamp sensor connection

- Check the following before connection.



#### **DANGER**

- Use the Voltage test leads supplied with this instrument.
- Use the dedicated clamp sensor for this instrument, and confirm that the measured current rating of the clamp sensor is not exceeded.
- Do not connect all the Voltage test leads or Clamp sensors unless required for measuring the parameters desired.
- Connect the test leads and sensors to the instrument first, and only then connect them to the circuit under test.
- Never disconnect the voltage test leads and sensors whilst the instrument is in use.



#### **WARNING**

- Confirm that the Function switch on the instrument is in the OFF position, and then connect the test leads and sensors.
- Connect the test leads and sensors firmly to the instrument first.
- Never attempt to make any measurement if any abnormal conditions are noted, such as a broken cover and exposed metal parts.

- Voltage test leads and clamp sensor connection

Follow the procedure below, and connect the Voltage test leads and Clamp sensors.

- (1) Confirm that the Function switch on the instrument is in the OFF position.
- (2) Connect the appropriate Voltage test leads to the Voltage input terminal on the instrument.
- (3) Connect the appropriate Clamp sensors to the Current input terminal on the instrument.

\* Match the direction of arrow marks indicated on the output terminal of the clamp sensor and the mark on the Current input terminal on the instrument.

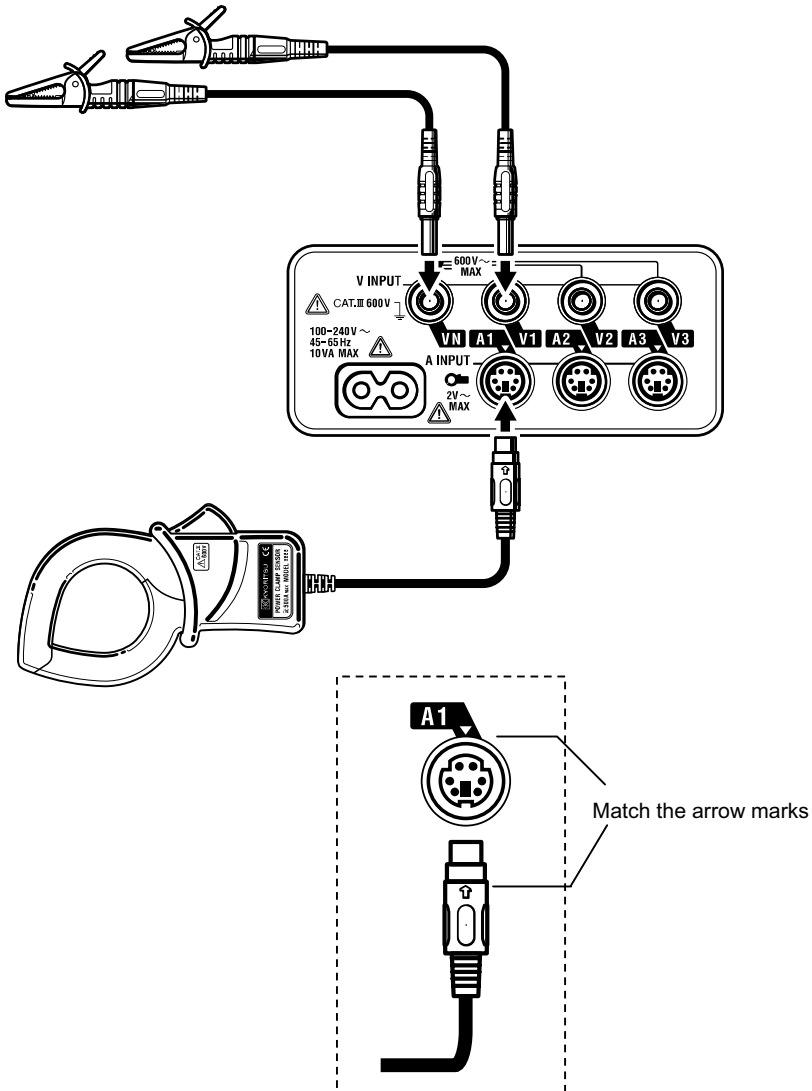
**NOTE**

- \* The number of Voltage test leads and Clamp sensors to be used depend on the wiring configuration to be measured. For further details, refer to “**Section 5: Wiring**” in this manual.

### 3-3 Turning on the instrument

#### 3-3-1 Start-up screen

Set the Function switch to any range other than the OFF position turns on the instrument. Then following screen appears.

1. All segments on

All segments are displayed for about 1sec., then the screen switches to the MODEL/VERSION screen and being displayed for about 2sec..

All segments are on  
(displayed for about 1sec.)



MODEL/VERSION screen  
(displayed for about 2sec.)

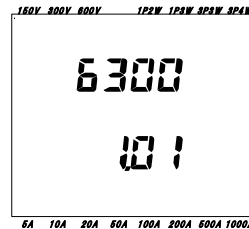

2. Display on each range

The following screen appears, depending on the position of Function switch.

**W** range

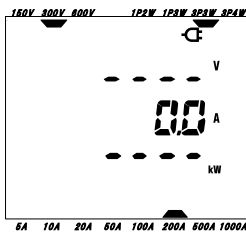

**Wh** range

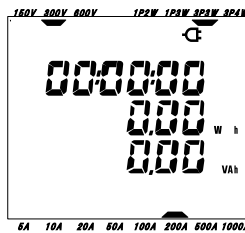

**DEMAND** range

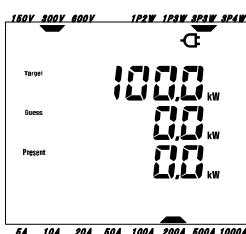

**SET UP** range

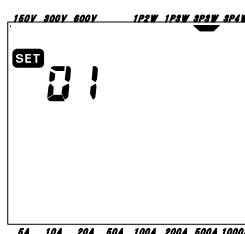



### 3-3-2 Error message

This instrument automatically checks the internal circuit immediately after it is turned on.

If a suspect failure in the internal circuit is detected, the error screen displayed below will be on for about 2sec. just before all segments are displayed on the LCD. In this case, refrain from using the instrument and refer to “**Section12: Troubleshooting**” in this manual.

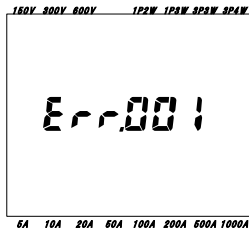

Error code (0 ~ 63)

Err.001

}

Err.063



#### CAUTION



Notwithstanding the error screen, the measurement screen will appear and the instrument will take measurements anyway. However, the accuracy of reading may be affected.

### 3-3-3 Battery Operation

This instrument operates either with AC power supply or batteries (typically for about 7 hours continuous measurement). When AC power supply is interrupted, the instrument operates on the batteries.

**⚠ WARNING**  
 Never touch the Power connector, even though it is insulated when the instrument is operating with batteries.



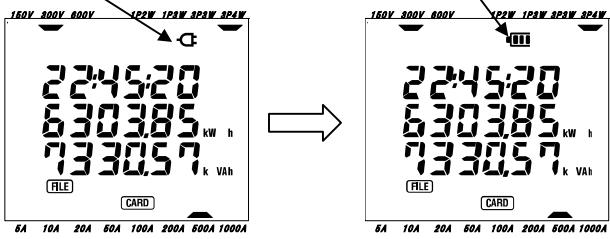

Measurement screen on each range switches as follows.

<AC power supply-operated>      <Battery-operated>  
 AC power supply mark  is displayed      Battery mark  is displayed



- Battery condition

Battery mark varies as follows depending on the battery condition.

Mark	Description	
	About 4 to 7 hours autonomy	NOTE: Using the backlight will rapidly reduce the battery's autonomy.
	2 to 4 hours autonomy	
	0 to 2 hours autonomy	
	Battery is exhausted. (accuracy of readings cannot be guaranteed) The following operations should be done not to loose data. * During instantaneous value measurement (after a file is opened), close the file and data will be saved. * During integration/ max demand measurement stop the measurement and the data will be saved.	

**NOTE**

- \* The batteries are not in the instrument at the time of purchase. Please insert the supplied batteries in the instrument. If the instrument will not be in use for a long period, remove the batteries.  
 For further details, please refer to “12-2 Battery replacement” in this manual.
- \* When the instrument is powered by AC power supply, it doesn't operate with batteries.
- \* If the AC supply is interrupted and the batteries have not been inserted, the instrument goes off and all data is lost.







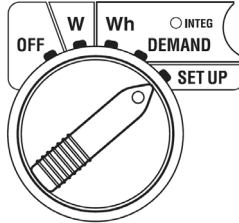

## 4. Setting

This section deals with settings for measurement and data saving.

Set the Function switch to **SET UP** range as follows.







• Key operation during Setup

Keys		Details
	<b>START/STOP</b> key	No use
	<b>BACKLIGHT</b> key	Switches on/off the backlight of the LCD.
	<b>UP &amp; DOWN</b> cursor key	<ul style="list-style-type: none"> <li>* To browse through setting items.</li> <li>* To change the details of setting items.</li> <li>* To change numbers.</li> </ul>
	<b>LEFT &amp; RIGHT</b> cursor key	<ul style="list-style-type: none"> <li>* To browse through setting items.</li> <li>* To change the value/status of setting items.</li> <li>* To select digits.</li> </ul>
	<b>ENTER</b> key	<ul style="list-style-type: none"> <li>* To select setting items.</li> <li>* Press this key on the desired setting item, thus going into the setting change mode. The previous value of that particular setting item will flicker.</li> </ul>
	<b>ESC</b> key	<ul style="list-style-type: none"> <li>* To cancel settings. Following above step, this key will cancel value selected, restore previous value and exit setting change mode .</li> </ul>
	<b>DATA HOLD</b> key	Data hold function is disabled. Pressing this key for at least 2 sec. disables all key operations. (except for Backlight switch)
	<b>SAVE</b> key	No use

## 4-1 List of setting items

List of setting items on **SET UP** range (25 items in total)

Item No.	Setting item	Mark	Default value	Clause
01	Wiring	-	3P3W	4-3-1
02	Voltage range	-	300V	4-3-2
03	Current range	-	200A	4-3-3
04	Clamp sensor		500A	4-3-4
05	VT ratio	<b>VT</b>	1	4-3-5
06	CT ratio	<b>CT</b>	1.00	4-3-6
07	Time		-	4-3-7
08	Buzzer		on	4-3-8
09	Integration interval	<b>INTEG</b> <b>INT</b>	30 min.	4-3-9
10	Integration start time & date	<b>INTEG</b> <b>START</b>	Time	4-3-10
11	Integration stop time & date	<b>INTEG</b> <b>STOP</b>	Time + Interval	4-3-11
12	Reset of integration value	<b>INTEG</b> <b>RESET</b>	oFF (not reset)	4-3-12
13	Demand Interval	<b>DEMAND</b> <b>INT</b>	30 min.	4-3-13
14	Demand start time & date	<b>DEMAND</b> <b>START</b>	Time	4-3-14
15	Demand stop time & date	<b>DEMAND</b> <b>STOP</b>	Time + Interval	4-3-15
16	Demand target value	<b>DEMAND</b> <b>Target</b>	100kW	4-3-16
17	Demand inspection cycle	<b>DEMAND</b> 	10 min.	4-3-17
18	Reset of demand value	<b>DEMAND</b> <b>RESET</b>	oFF (not reset)	4-3-18
19	Use of CF card	<b>CARD</b>	-	4-3-19
20	Formatting CF card		oFF (not formatted)	4-3-20
21	Deleting the data in CF card		not.dEL (not deleted)	4-3-21
22	Deleting the data in internal memory	<b>MEM</b>	not.dEL (not deleted)	4-3-22
23	System reset	<b>RESET</b>	oFF (not reset)	4-3-23
24	Loading settings	<b>CONF</b>	-	4-3-24
25	Saving settings		-	4-3-25

Hereinafter, each setting is called as “**Setting XX**”.

### NOTE

\* For setting items 12, 18, 20, 21, 22 and 23, previous values are not displayed, and the default value is always effective. Refer to the setting procedure of each setting item.

## 4-2 Classification of setting items

- **Basic setting**

These are the basic settings for measurement of instantaneous value, integration value and demand value.

- “Setting 01” Wiring
- “Setting 02” Voltage range
- “Setting 03” Current range
- “Setting 04” Clamp sensor
- “Setting 05” VT ratio (if necessary)
- “Setting 06” CT ratio (if necessary)

- **Setting only for integration measurement** <only at integration value measurement>

- “Setting 09” Integration interval
- “Setting 10” Integration start time and date  
(To start measurement at the set time and date)
- “Setting 11” Integration stop time and date  
(To stop measurement at the set time and date)
- “Setting 12” Reset of integration value

- **Setting only for demand measurement** <only at demand value measurement>

- “Setting 13” Demand interval
- “Setting 14” Demand start time and date  
(To start measurement at the set time and date)
- “Setting 15” Demand stop time and date  
(To stop measurement at the set time and date)
- “Setting 16” Demand target value
- “Setting 17” Demand inspection cycle
- “Setting 18” Reset of demand value

- **Setting only for CF card**

- “Setting 19” Use of CF card
- “Setting 20” Formatting CF card
- “Setting 21” Deleting the data in CF card

- **Others**

- “Setting 07” Time
- “Setting 08” Buzzer
- “Setting 22” Deleting the data in internal memory
- “Setting 23” System reset
- “Setting 24” Loading settings
- “Setting 25” Saving settings

### 4-3 Setting procedure of each setting item

#### NOTE

During the integration/demand measurement or in stand-by mode, the settings can be viewed only for checking and cannot be changed.

- (1) Setting item selection screen (hereinafter, called selection screen)

- \* Set the Function switch to **SET UP** range.
- \* Then selection screen is displayed, and “**SET**” mark and item number appear.
- \* When turning on the instrument, setting screen for; “**Setting 01**”: Wiring, is displayed.

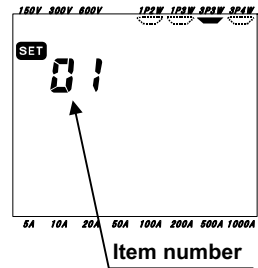

- (2) Setting Item number selection

- \* Press the **Cursor** key and select the desired item number.
- \* Item number changes in following sequence.

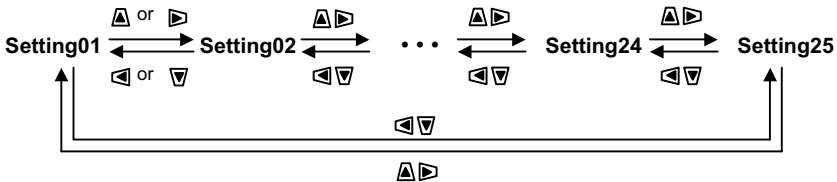

- (3) Changing the value/status of a Setting item

- \* Select the item number desired, press the **ENTER** key to go into setting change mode.
- \* When the instrument is in setting change mode, the previous set value (or default value) will flicker.
- \* Press the **Cursor** key and select the value/status desired.
- \* Press the **ENTER** key to confirm the selection.

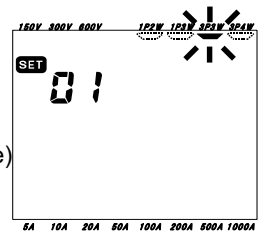

- (4) Selection cancellation

- \* Following step (3) above, press the **Esc** key. This will cancel value/status selected, restore the previous values and exit setting change mode.

### 4-3-1 “Setting 01” Wiring

Setting item	1P2W(1ch)	: Single-phase 2-wire (1ch)
	1P2W(2ch)	: Single-phase 2-wire (2ch)
	1P2W(3ch)	: Single-phase 2-wire (3ch)
	1P3W	: Single-phase 3-wire
	3P3W	: Three-phase 3-wire
	3P4W	: Three-phase 4-wire
Default value	3P3W	

- \* Using the **Cursor** key whilst in the selection screen, select “Setting 01”.
- \* Press the **ENTER** key to enter setting change mode.
- \* Previous setting (or default value: 3P3W) flickers. Select the desired wiring configuration with the **Cursor** key, and then press the **ENTER** key.

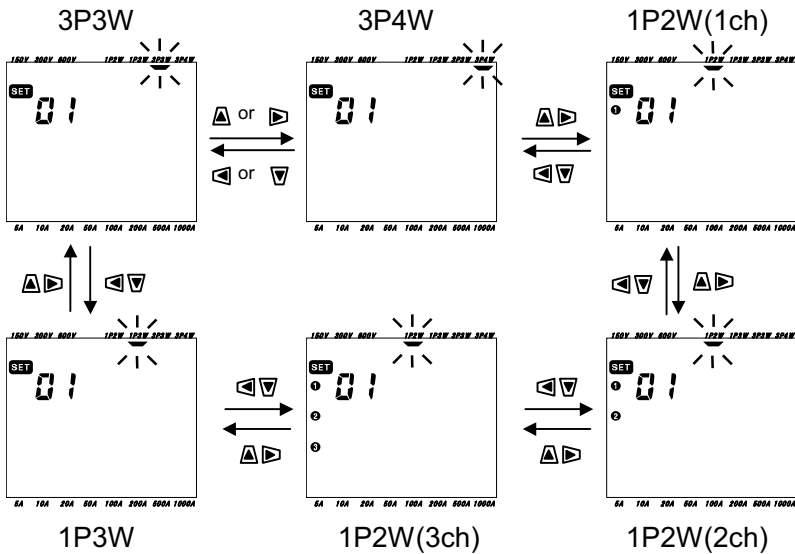

**4-3-2 “Setting 02” Voltage range**

Setting item	150V/ 300V/ 600V
Default value	300V

- \* Using the **Cursor** key whilst in the selection screen, select “Setting 02”.
- \* Press the **ENTER** key to enter setting change mode.
- \* Previous setting (or default value: 300V) flickers. Select the desired voltage range with the **Cursor** key, and then press the **ENTER** key.

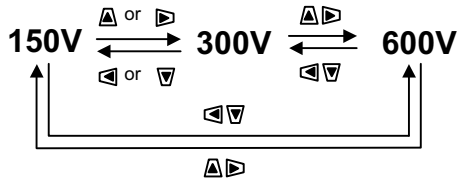
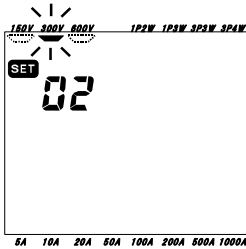



### 4-3-3 “Setting 03” Current range

Current range varies depending on the selected Clamp sensor which is done at “**Setting 04**” in the next section.

Clamp sensor (“ <b>Setting 04</b> ”)	Current range
50A (M-8128)	5A / 10A / 20A / 50A
100A (M-8127)	10A / 20A / 50A / 100A
200A (M-8126)	20A / 50A / 100A / 200A
500A (M-8125)	50A / 100A / 200A / 500A
1000A (M-8124)	100A / 200A / 500A / 1000A
3000A	1000A / 3000A (*)
Default value	200A

\* On 3000A range, CT ratio (“**Setting 06**”) has been set to 3.00.

- \* Using the **Cursor** key whilst in the selection screen, select “Setting 03”.
- \* Press the **ENTER** key to enter setting change mode.
- \* Previous setting(or default value) flickers. Select the desired current range with the **Cursor** key, and then press the **ENTER** key.

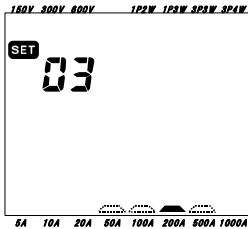

<When 500A type of clamp sensor is selected at “**Setting 04**”>

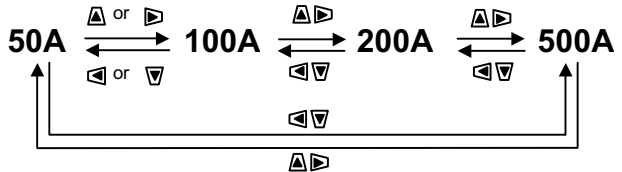

#### NOTE

- \* When the clamp sensor (“**Setting 04**”) is changed, the current range will also change accordingly.
- \* When the Clamp sensor in use is different from the setting for the sensor made at “**Setting 04**”, readings obtained are not correct.

### 4-3-4 “Setting 04” Clamp sensor



Current range (“**Setting 03**”) varies depending on the selected clamp sensor.

Clamp sensor	Current range (“ <b>Setting 03</b> ”)
<b>50A (M-8128)</b>	5A / 10A / 20A / 50A
<b>100A (M-8127)</b>	10A / 20A / 50A / 100A
<b>200A (M-8126)</b>	20A / 50A / 100A / 200A
<b>500A (M-8125)</b>	50A / 100A / 200A / 500A
<b>1000A (M-8124)</b>	100A / 200A / 500A / 1000A
<b>3000A</b>	1000A / 3000A
Default value	500A

- \* Using the **Cursor** key whilst in the selection screen, select “Setting 04”.
- \* Press the **ENTER** key to enter setting change mode.
- \* Previous setting (or default value) flickers. Select the desired clamp sensor with the **Cursor** key, and then press the **ENTER** key.

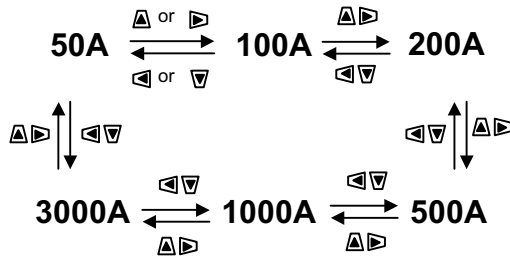
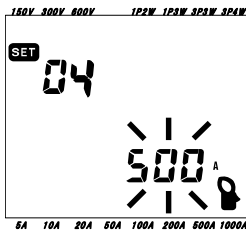

#### NOTE

- \* When the clamp sensor (“**Setting 04**”) is changed, the current range will also change accordingly.
- \* When the Clamp sensor in use is different from the setting for the sensor made at “**Setting 04**”, readings obtained are not correct.
- \* The whole range of Clamp sensors is not yet available. For more information, please contact your local KYORITSU distributor.

### 4-3-5 “Setting 05” VT ratio

**VT**

For the detailed information about VT ratio, refer to “5-3 VT/CT” in this manual.

Setting range	1 ~ 10000
Default value	1

- \* Using the **Cursor** key whilst in the selection screen, select “Setting 05”.
- \* Press the **ENTER** key to enter setting change mode.
- \* The rightmost digit of previous setting (or default value: 00001) flickers.
- \* Change the number with the **Cursor** key, and then press the **ENTER** key.

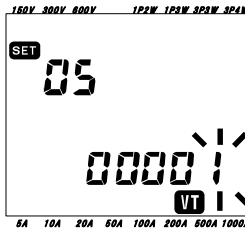

Function of **Cursor** keys

	To select the desired digit.
	To change the value of selected digit.

When VT ratio is set to other than 1, “**VT**” mark appears on each measurement screen.

#### NOTE

- \* When 0 is set as a VT ratio, it is automatically changed to 1.  
In case that a value of 10000 or more is set, it is automatically changed to 10000.
- \* If a value cannot be set as a VT ratio, a message “**SELEERR**” is displayed on the LCD, and the value returns to the previous set value.

(Voltage range “**Setting 02**”) x 120% x (Current range “**Setting 03**”) x 120%  
x (VT ratio) x (CT ratio “**Setting 06**”) > 9999G (G=10<sup>9</sup>)

4-3-6 “Setting 06” CT ratio



For the detailed information about CT ratio, refer to “5-3 VT/CT” in this manual.

Setting range	1.00 ~ 10000.0
Default value	1.00

- \* Using the **Cursor** key whilst in the selection screen, select “Setting 06”.
- \* Press the **ENTER** key to enter setting change mode.
- \* The rightmost digit of previous setting (or default value: 1.00) flickers.
- \* Change the number with the **Cursor** key, and then press the **ENTER** key.

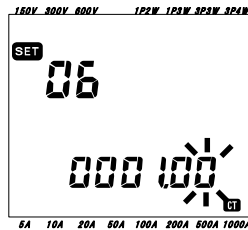

Function of **Cursor** keys

	To select the desired digit.
	To change the value of selected digit.

When CT ratio is set to other than 1.00, “**CT**” mark appears on each measurement screen.

**NOTE**

- \* When a value between 0.00 ~ 0.99 is set as a CT ratio, it is automatically changed to 1.00. In case that a value of 10000 or more is set, it is automatically changed to 10000.
- \* When the 3000A clamp sensor is selected at “Setting 04”, and Current range is set to 3000A at “**Setting 03**”, the CT ratio should be set to 3.00.
- \* If the setting of Clamp sensor (“**Setting 04**”) is changed after setting the CT ratio, the CT ratio automatically returns to 1.00.
- \* If a value cannot be set as a CT ratio. A message “**SELEErr**” is displayed on the LCD, and the value returns to the previous set value.

$$(Voltage\ range\ \textbf{“Setting 02”}) \times 120\% \times (Current\ range\ \textbf{“Setting 03”}) \times 120\% \times (VT\ ratio\ \textbf{“Setting 05”}) \times (CT\ ratio) > 9999G\ (G=10^9)$$

4-3-7 “Setting 07” Time



- \* Using the **Cursor** key whilst in the selection screen, select “Setting 07”.
- \* Press the **ENTER** key to enter setting change mode.
- \* Then minute flickers as shown. Select the date/time parameter desired with Left & Right **Cursor** key and modify it with Up & Down **Cursor** key.
- \* Then press the **ENTER** key.

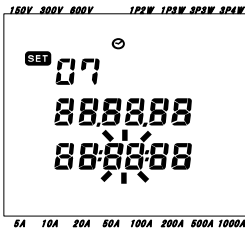

Time parameter	Setting range
second	Cannot be set (*1)
minute	00 ~ 59
hour	00 ~ 23
day	01 ~ 31 (*2)
month	01 ~ 12
year	00 ~ 99 (*3)

(\*1) It is automatically set to 00.

(\*2) If a date outside this range is selected, it will be automatically changed to 01.

(\*3) Only the last 2 digits are set. (e.g. 2004 → 04)

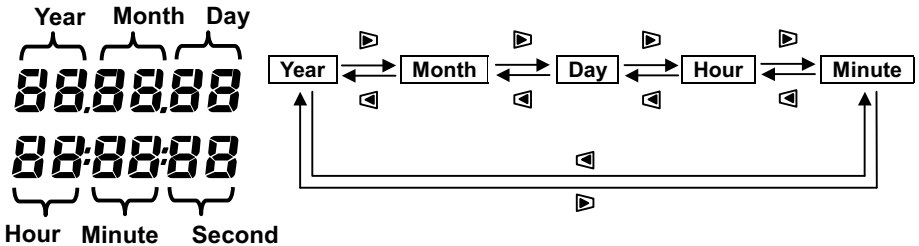

Function of **Cursor** keys

	To select a time parameter subject to change.
	To change the number of selected time parameter.

## 4-3-8 "Setting 08" Buzzer



- \* Using the **Cursor** key whilst in the selection screen, select "Setting 08".
- \* Press the **ENTER** key to enter setting change mode.
- \* Previous setting (or default value: on) flickers. Press the **Cursor** key to select on (sound) or OFF(no sound).
- \* Then press the **ENTER** key.

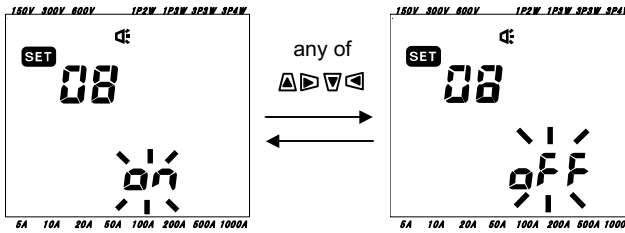

## 4-3-9 “Setting 09” Integration interval



The Integration interval is a preset period of time. Each time this interval elapses, the data measured (in integration mode) during that interval, is saved into the CF card or the internal memory.

Setting time	1/ 2/ 5/ 10/ 15/ 20/ 30 sec. 1/ 2/ 5/ 10/ 15/ 20/ 30 min. 1 hour
Default value	30 min.

- \* Using the **Cursor** key whilst in the selection screen, select “Setting 09”.
- \* Press the **ENTER** key to enter setting change mode.
- \* Previous setting (or default value: 30 min.) flickers. Press the **Cursor** key to select any desired interval.
- \* Then press the **ENTER** key.

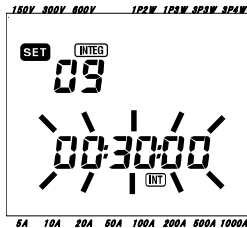

4-3-10 “Setting 10” Integration start time and date



- \* Using the **Cursor** key whilst in the selection screen, select “Setting 10”.
- \* Press the **ENTER** key to enter setting change mode.
- \* The current time and date plus 1 min. are displayed on the LCD, and the seconds digit will flicker.
- \* Change the time with the **Cursor** key, and then press the **ENTER** key.

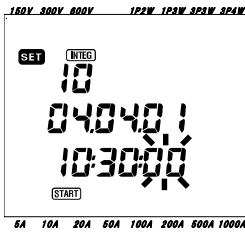

Time parameter	Setting range
second	00 ~ 59
minute	00 ~ 59
hour	00 ~ 23
day	01 ~ 31 (*1)
month	01 ~ 12
year	00 ~ 99 (*2)

(\*1) If a date outside this range is selected, a message “SEtErr” is displayed and it automatically changed to 00.

(\*2) Only the last 2 digits are set. (e.g. 2004 → 04)

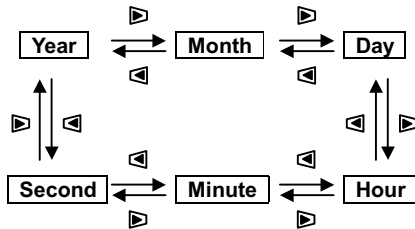

Function of **Cursor** keys

	To select the desired time parameter.
	To change the value of selected time parameter.

**NOTE**

- \* Although the Start time can be set in the past, integration measurement only starts upon pressing the **STRAT/STOP** key on **Wh** range.
- For more detailed information, please refer to “Section 7: Integration value measurement” in this manual.



### 4-3-11 “Setting 11” Integration stop time and date



- \* Using the **Cursor** key whilst in the selection screen, select “Setting 11”.
- \* Press the **ENTER** key to enter setting change mode.
- \* Time and date; Integration start time and date (“**Setting 10**”) plus Integration interval (“**Setting 09**”), are displayed on the LCD, and second digits flicker.
- \* Change the time with the **Cursor** key, and then press the **ENTER** key.

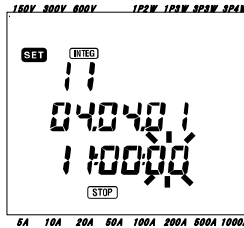

For further details, refer to Integration start time and date (“**Setting 10**”) in this manual.

#### NOTE

- \* The period between start and stop time of integration measurement can be set to a shorter time than the integration interval (“**Setting 09**”). However, the measured data will not be recorded.

### 4-3-12 “Setting 12” Reset of integration value



The integration value (i.e. counters) can be reset as follows.

- \* Using the **Cursor** key whilst in the selection screen, select “Setting 12”.
- \* Press the **ENTER** key to enter setting change mode.
- \* On the LCD, “oFF”(not reset) will flicker. Then change it to “on”(reset) with **Cursor** key.
- \* Then press the **ENTER** key.

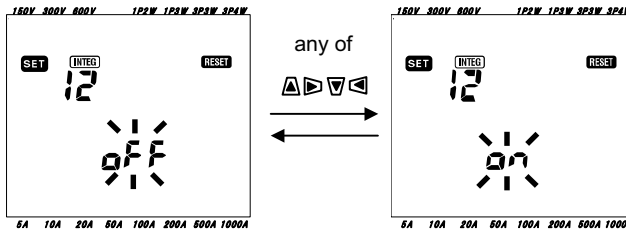

#### NOTE

- \* This setting is also available on **Wh** range.  
For further details, refer to “**Section 7: Integration value measurement**” in this manual.
- \* The default value is always “oFF”.

## 4-3-13 "Setting 13" Demand interval

**DEMAND** **INT**

The demand interval is a preset period of time. Each time this interval elapses, the data measured (in demand mode) during that interval, is saved into the CF card or the internal memory.

Setting time	1/ 2/ 5/ 10/ 15/ 20/ 30 sec. 1/ 2/ 5/ 10/ 15/ 20/ 30 min. 1 hour
Default value	30 min.

- \* Using the **Cursor** key whilst in the selection screen, select "Setting 13".
- \* Press the **ENTER** key to enter setting change mode.
- \* Previous setting (or default value: 30 min.) flickers. Press the **Cursor** key to select any desired interval.
- \* Then press the **ENTER** key.

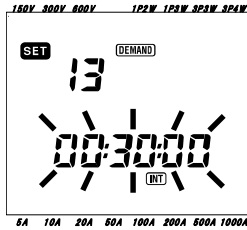

4-3-14 “Setting 14 Demand start time and date

**DEMAND START**

- \* Using the **Cursor** key whilst in the selection screen, select “Setting 14”.
- \* Press the **ENTER** key to enter setting change mode.
- \* The current time and date plus 1 min. are displayed on the LCD, and the seconds digit will flicker.
- \* Change the time with the **Cursor** key, and then press the **ENTER** key.

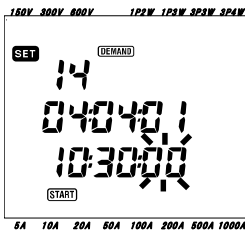

Time parameter	Setting range
second	00 ~ 59
minute	00 ~ 59
hour	00 ~ 23
day	01 ~ 31 (*1)
month	01 ~ 12
year	00 ~ 99 (*2)

- (\*1) If a date outside this range is selected, a message “**SEERR**” is displayed and it automatically changed to 00.
- (\*2) Only the last 2 digits are set. (e.g. 2004 → 04)

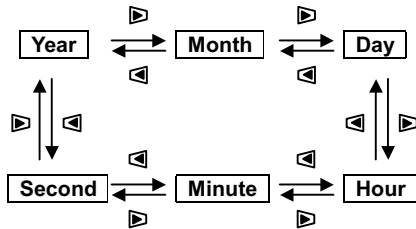

Function of **Cursor** keys

	To select the desired time parameter.
	To change the value of selected time parameter.

Section 4

### 4-3-15 “Setting 15” Demand stop time and date



- \* Using the **Cursor** key whilst in the selection screen, select “Setting 15”.
- \* Press the **ENTER** key to enter setting change mode.
- \* Time and date; demand start time and date (“**Setting 14**”) plus demand interval (“**Setting 13**”) are displayed on the LCD, and the seconds digit will flicker.
- \* Change the time with the **Cursor** key, and then press the **ENTER** key.

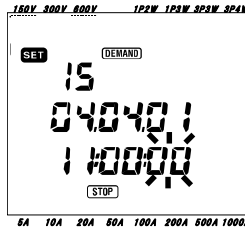

For further details, refer to demand start time and date (“**Setting 14**”) in this manual.

#### NOTE

- \* The period between start and stop time of demand measurement can be set to a shorter time than the demand interval (“**Setting 13**”). However, the measured data will not be recorded.

### 4-3-16 “Setting 16” Demand target value

## **DEMAND** Target



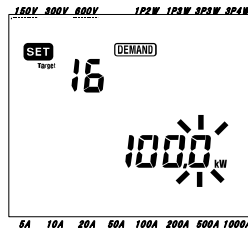

For further details about demand target value, refer to “Section 8: Demand value measurement” in this manual. Target value can be set between 0.1W and 999.9GW.

Demand target value	0.1 ~ 999.9	W
	0.1 ~ 999.9	kW
	0.1 ~ 999.9	MW
	0.1 ~ 999.9	GW
Default value	100.0kW	

- \* Using the **Cursor** key whilst in the selection screen, select “Setting 16”.
- \* Press the **ENTER** key to enter setting change mode.
- \* Previous setting (or default value: 100.0kW) flickers. Press the **Cursor** key to set any desired value and unit.
- \* Then press the **ENTER** key.



Function of **Cursor** keys

 	To select the desired digit or unit parameter.
 	To change the value of selected digit or unit.

#### NOTE

- \* When the target value is set to 0, it is automatically changed into 100.0.

## 4-3-17 “Setting 17” Demand inspection cycle



For further information on Demand inspection cycle, refer to “Section 8: Demand measurement” in this manual.

Depending on the demand interval chosen, at “Setting 13”, the inspection cycle can be set as follows.

Demand interval (“Setting 13”)	Inspection cycle
1 sec./ 2 sec./ 5 sec.	Cannot be set.
10 sec.	1 sec./ 2 sec./ 5 sec.
15 sec.	2 sec./ 5 sec./ 10 sec.
20 sec.	5 sec./ 10 sec./ 15 sec.
30 sec.	10 sec./ 15 sec./ 20 sec.
1 min.	15 sec./ 20 sec./ 30 sec.
2 min.	20 sec./ 30 sec./ 1 min.
5 min.	30 sec./ 1 min./ 2 min.
10 min.	1 min./ 2 min./ 5min.
15 min.	2 min./ 5min./ 10 min.
20 min.	5min./ 10 min./ 15 min.
30 min.	10 min./ 15 min./ 20 min.
1 hour	15 min./ 20 min./ 30min.
Default value	10 min.

- \* Using the **CURSOR** key whilst in the selection screen, select “Setting 17”.
- \* Press the **ENTER** key to enter setting change mode.
- \* Previous setting (or default value: 10 min.) flickers. Press the **CURSOR** key, and select the desired cycle. Then press the **ENTER** key.

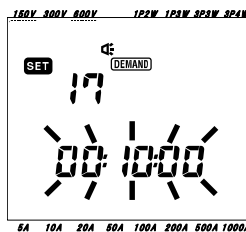

### 4-3-18 “Setting 18” Reset of demand value



The demand (target / value measurement) value recorded in a previous demand measurement can be reset as follows.

- \* Using the **Cursor** key whilst in the selection screen, select “Setting 18”.
- \* Press the **ENTER** key to enter setting change mode.
- \* On the LCD, “oFF”(not reset) will flicker. Then change it to “on”(reset) with **Cursor** key, and press the **ENTER** key.

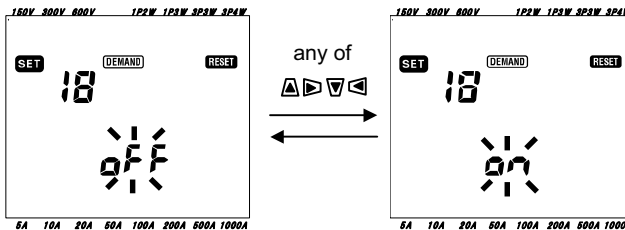

#### NOTE

- \* This setting is also available on **DEMAND** range.  
For more detailed information, refer to “**Section 8: Demand value measurement**” in this manual.
- \* When the demand value is reset, the integration value will be also reset.
- \* The default value is always “oFF”.



## 4-3-19 “Setting 19” Use of CF card



For the detailed information about CF card, refer to “Section 9: CF card/Internal memory” in this manual.

**CAUTION**

Always set the Function switch to the OFF position before inserting/removing a CF card. If a CF card is inserted/removed with the instrument on, saved data may be lost or instrument may be damaged.

- \* Using the **Cursor** key whilst in the selection screen, select “Setting 19”.
- \* Press the **ENTER** key to enter setting change mode.

<With the CF card placed in the instrument>

- \* “rEC.on” is displayed on LCD. [“on” (when using a CF card) will flicker]
- \* Notwithstanding the presence of the CFcard, if the data is to be saved to the internal memory, press **Cursor** key to change the indication into “oFF”. (“oFF”:i.e. not using a CF card). Otherwise this step is to be ignored.
- \* Then press the **ENTER** key.

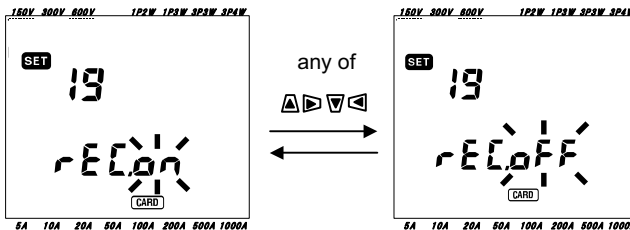

<Without CF card >

- \* “rEC.oFF” is displayed on LCD (“oFF” will flicker). This cannot be altered. The measured data is automatically saved to the internal memory.

**NOTE**

- \* The instrument automatically identifies a CF card when it is turned on.
- \* If necessary, check the condition of the CF card on other hardware.
- \* Refer to the CF card instruction manual for further details on the card.

### 4-3-20 “Setting 20” Formatting CF card



A new CF card has to be formatted before use.

For the detailed information about the CF card, refer to “Section 9: CF card/Internal memory” in this manual.

**CAUTION**

Always set the Function switch to the OFF position before inserting/removing a CF card. If a CF card is inserted/removed while the instrument is on, saved data may be lost or the instrument may be damaged.

- \* Confirm that the Function switch is in the OFF position, and insert the CF card into the CF card connector of the instrument.
- \* Set the Function switch to **SET UP** range.
- \* Using the **Cursor** key whilst in the selection screen, select “Setting 20”.
- \* Press the **ENTER** key to enter setting change mode.
- \* The message “oFF”(i.e. not formatted) will flicker. Change it to “on”(formatted) with the **Cursor** key. If the CF card is not inserted, it cannot be set to “on”.

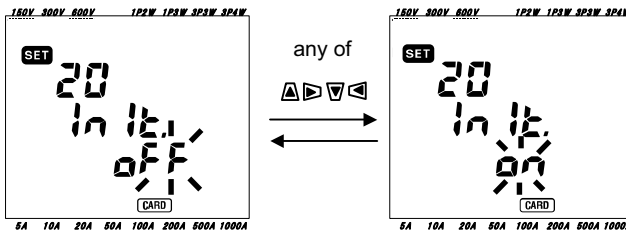

On pressing the **ENTER** key, formatting will start. Formatting takes a few seconds. After formatting is complete, a message “InIt. FlnSh” is displayed on the LCD.



Section 4

**NOTE**

- \* All data in the CF card will be deleted after formatting.
- \* The instrument automatically identifies a CF card when it is turned on.
- \* The default value is always "oFF" (not formatted).
- \* If necessary, check the condition of the CF card on other hardware.
- \* Refer to the CF card instruction manual for further details on the card.

## 4-3-21 “Setting 21” Deleting the data in CF card



For further detailed information on the CF card, refer to “Section 9: CF card/Internal memory” in this manual.

**CAUTION**

Set the Function switch to OFF position before inserting/removing the CF card. If a CF card is inserted/removed while the instrument is on, saved data may be lost or the instrument may be damaged.

- \* Confirm that the Function switch is in the OFF position, and insert the CF card into the CF card connector of the instrument.
- \* Set the Function switch to **SET UP** range.
- \* Using the **Cursor** key whilst in the selection screen, select “Setting 21”.
- \* Press the **ENTER** key to enter setting change mode.
- \* The message “not.dEL”(not deleted) will flicker. Change it to “dEL”(deleted) with the **Cursor** key. If the CF card is not inserted, it cannot be set to “on”.
- \* When pressing the **ENTER** key, the data is deleted. It takes a few minutes to delete the data.

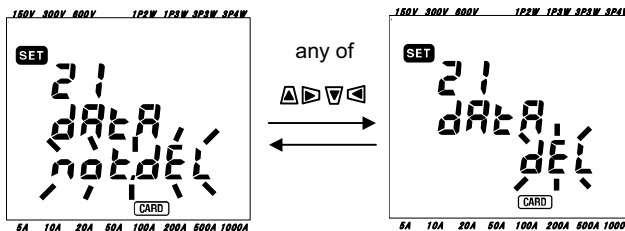

**NOTE**

- \* The instrument automatically identifies a CF card when it is turned on.
- \* The default value is always “not.dEL”.
- \* If necessary, check the condition of the CF card on other hardware.
- \* Refer to the CF card instruction manual for further details on the card.

### 4-3-22 “Setting 22” Deleting the data in internal memory



For further information on the internal memory, refer to “Section 9: CF card / Internal memory” in this manual.

- \* Using the **Cursor** key whilst in the selection screen, select “Setting 22”.
- \* Press the **ENTER** key to enter setting change mode.
- \* The message “not.dEL”(not deleted) will flicker. Change it to “dEL”(deleted) with **Cursor** key.
- \* When pressing the **ENTER** key, the data is deleted.

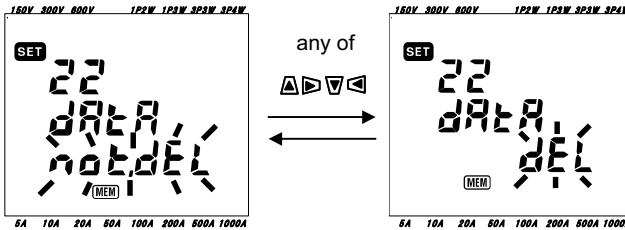

#### NOTE

- \* The default value is always “not.dEL”.

## 4-3-23 “Setting 23” System reset

**RESET**

For further details about system reset, refer to “**Section 11: Other functions**” in this manual.

- \* Using the **Cursor** key whilst in the selection screen, select “Setting 23”.
- \* Press the **ENTER** key to enter setting change mode.
- \* The message “oFF”(not reset) will flicker. Change it to “on”(reset) with **Cursor** key.
- \* When pressing the **ENTER** key again, system is reset.

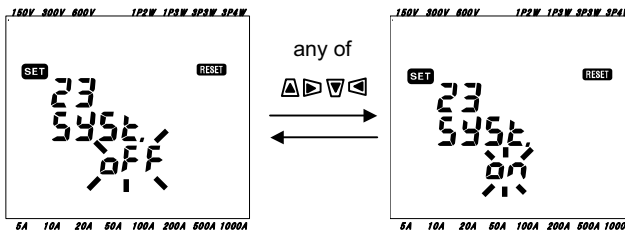
**NOTE**

- \* The default value is always “oFF”.

#### 4-3-24 “Setting 24” Loading settings

**CONF**

This sections explains the loading procedure of settings saved at “**Setting 25**” explained in section 4-3-25.

- \* Using the **Cursor** key whilst in the selection screen, select “Setting 24”.
- \* Press the **ENTER** key to enter setting change mode
- \* Select a tag from 01 and 20 with **Cursor** key.
- \* Then press the **ENTER** key.

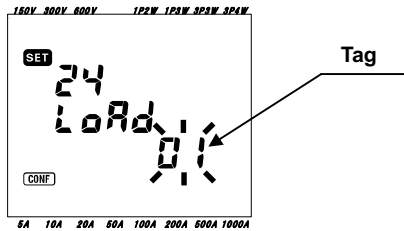

#### NOTE

- \* When loading a Tag which has not been previously created at “**Setting 25**”, the value of each of the seven setting items (listed in the table on the next page) returns to default value.

4-3-25 “Setting 25” Saving settings



This instrument can memorize and recall the user’s preferred values for the seven setting items listed below after inputting and saving the required values in each of the listed seven settings.

- \* Using the **Cursor** key whilst in the selection screen, select “Setting 25”.
  - \* Press the **ENTER** key to enter setting change mode.
  - \* Assign a tag from 01 and 20 with **Cursor** key.
  - \* Then press the **ENTER** key.
  - \* When required, the “tagged” settings may be loaded from “**Setting 24**”.
- Available Tags: 01 ~ 20

Setting Item number	
Setting 01	Wiring
Setting 02	Voltage range
Setting 03	Current range
Setting 04	Clamp sensor
Setting 05	VT ratio
Setting 06	CT ratio
Setting 08	Buzzer

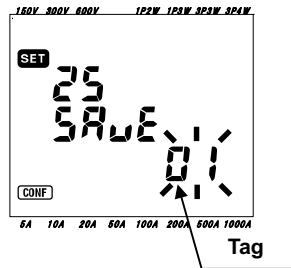

**NOTE**

- \* When assigning a tag, the last inputted setting values always overwrite the previous values.
- \* Tags can be selected from 01 and 20.
- \* All tags will return to the default values after system reset.



## 5. Wiring configurations

### 5-1 Important Preliminary checks

#### **DANGER**

- Do not make measurements on a circuit in which the electrical potential exceeds AC600V.
- Connect the Power cord to a socket outlet. Never connect it to the socket outlet of AC240V or more.
- The Clamp sensor, Voltage test leads and Power cord are to be connected to the instrument first.
- The Voltage test leads or Clamp sensors should not be connected to the input terminals of the instrument if not required for measurement.
- The instrument should always be connected on the downstream side of a circuit breaker, which is safer than the upstream side.
- Do not open-circuit the secondary side of a supplementary CT while it is energized because of the high voltage generated at the secondary side terminals.
- Be careful to avoid short-circuiting the power line with the un-insulated part of the voltage test probes during the setting up of the instrument. Transformer jaw tips are designed in such a way to avoid short-circuiting. If the circuit under test has exposed conductive parts, extra care should be taken to minimize the possibility of shorting.

#### **WARNING**

- To avoid possible electric shock and short-circuit, always turn off the line under test when setting up the instrument.
- Do not touch the un-insulated tip of Voltage test probes. The use of safety insulated gloves is recommended.

- Clamp sensor direction for correct measurement:  
Ensure that the arrow mark on the clamp sensor points towards to load side.

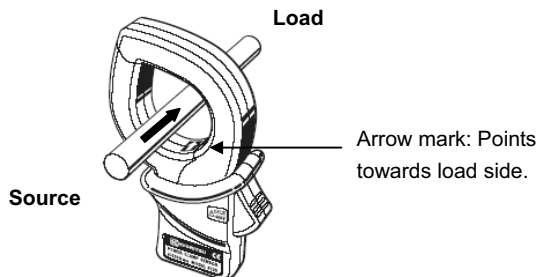

### 5-2 Basic wiring configurations

- Wiring method for single-phase 2-wire (1ch) "1P2W (1ch)"

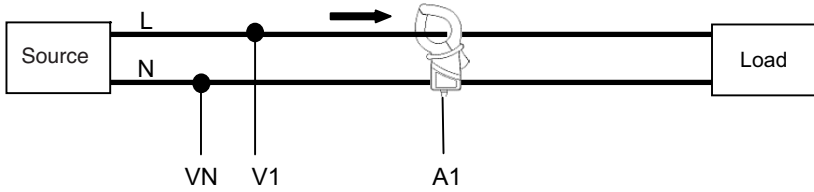

- Wiring method for single-phase 2-wire (2ch) "1P2W (2ch)"

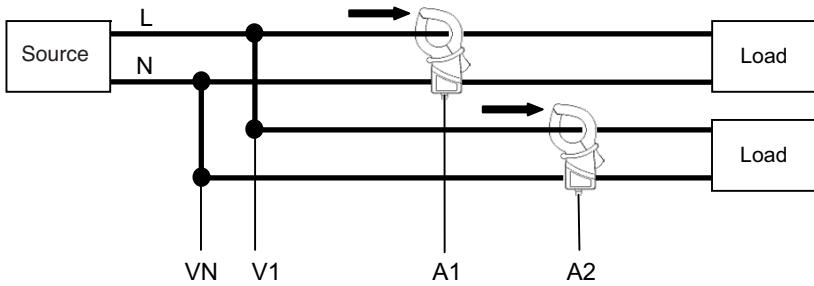

- Wiring method for single-phase 2-wire (3ch) "1P2W (3ch)"

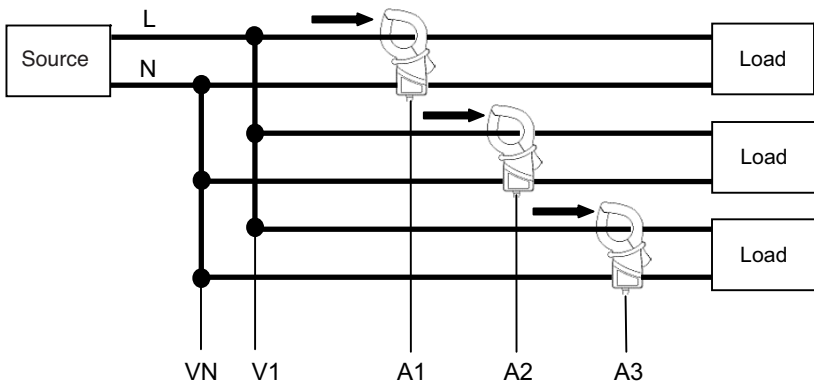

Section 5

- Wiring method for single-phase 3-wire "1P3W"

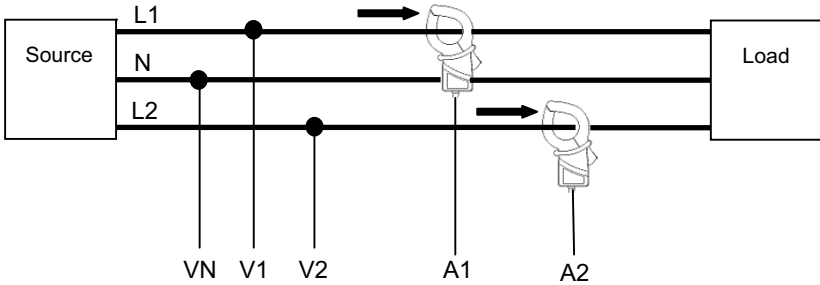

- Wiring method for three-phase 3-wire "3P3W"

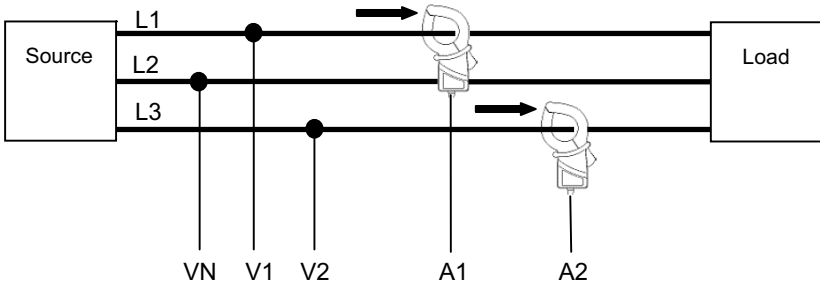

- Wiring method for three-phase 4-wire "3P4W"

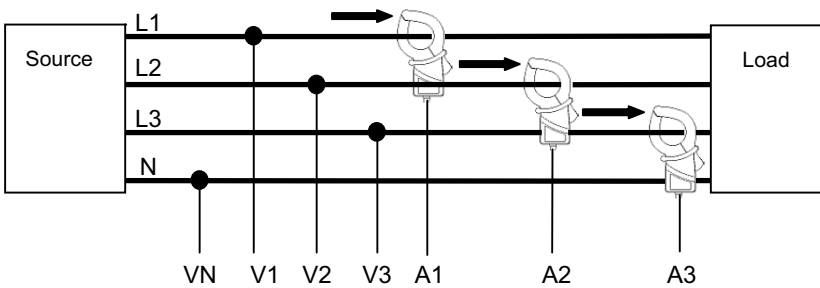

### 5-3 Using supplementary VT/ CT's (not supplied with the instrument)

#### DANGER

- Never make measurement on a circuit in which electrical potential exceeds AC600V.
- Connect the Power cord to a socket outlet. Never connect it to the socket outlet of AC240V or more.
- This instrument must be used on the secondary side of VT(transformer) and CT(current transformer).
- Do not open-circuit the secondary side of a supplementary CT while it is energized because of the high voltage generated at the secondary side terminals.

#### CAUTION

- When a VT or CT is used the measurement accuracy is not guaranteed due to several factors namely phase characteristics and VT/CT accuracies.

The use of supplementary VT/CT's may be required if the voltage/current values of the circuit under test fall outside the instrument measuring range. In this case the value at the primary side of circuit can be obtained directly by measuring the secondary side with appropriate an VT or CT installed in the line under test as follows.

<Example of single-phase 2-wire (1ch) "1P2W(1ch)">

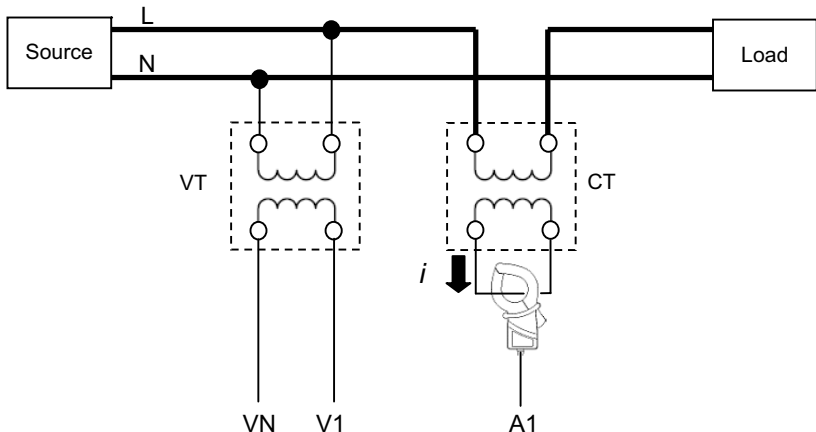

In this case, set the actual ratio of VT and CT to be used.

\* VT ratio: **"Setting 05"**

\* CT ratio: **"Setting 06"**

## 6. Instantaneous value measurement

Set the Function switch to **W** range.

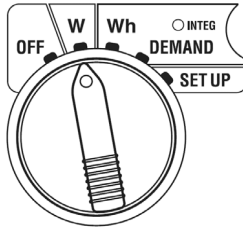

During Inst. value measurement, if the Function switch is set to a position other than **W**, it results in the following;

- Wh** range : No effect
- DEMAND** range : No effect
- SET UP** range : Change/ Confirm the settings  
(see “**Section 4: Settings**”)

### • Indications

Measurement/Calculation parameter		Unit
Voltage (RMS)	$V_i$ : Voltage per phase( $V_1, V_2, V_3$ )	V
Current (RMS)	$A_i$ : Current per phase( $A_1, A_2, A_3$ )	A
Active power	$P$ : Total active power $P_i$ : Active power per phase Polarity: (no mark) consumption, - (minus) regenerating	W
Reactive power	$Q$ : Total reactive power $Q_i$ : Reactive power per phase Polarity: (no mark) phase lag, - (minus) phase lead	Var
Apparent power	$S$ : Total apparent power $S_i$ : Apparent power per phase	VA
Power factor ( $\cos \phi$ )	PF : Power factor of whole system $Pf_i$ : Power factor per phase Polarity:(no mark) phase lag, - (minus) phase lead	PF
Frequency	$f$ : Frequency of $V_1$	Hz
Neutral current	$I_n$ : neutral current (only at three-phase 4-wire)	An

$i = 1, 2, 3$

Displayed parameters can be changed according to needs.

Refer to “**6-3 Customizing display**” in this manual.

### NOTE





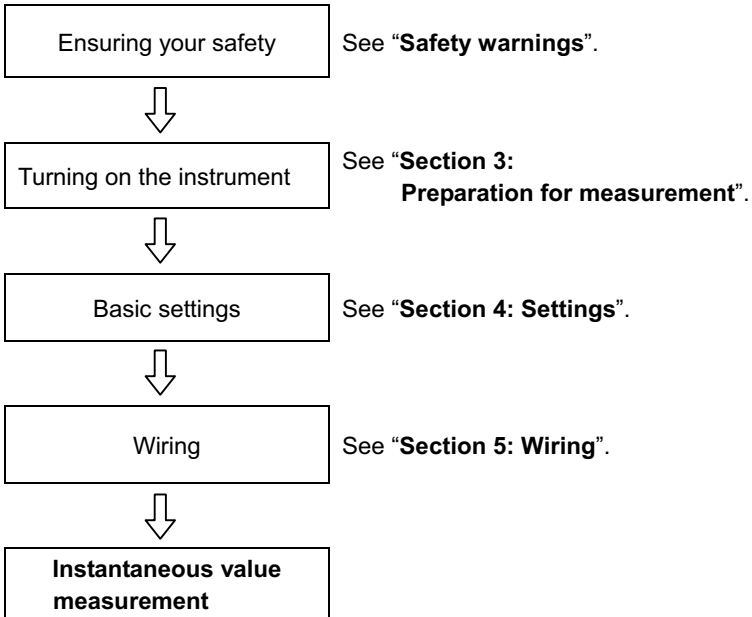



- \* Above parameters vary depending on each wiring configuration.
- \* If  $V_1$  is out of measuring range, other parameters may not be measured or calculated.
- \* The chosen units for the power factor and neutral current are arbitrary.

- Prior to making a measurement



- Basic settings
  - “**Setting 01**” Wiring
  - “**Setting 02**” Voltage range
  - “**Setting 03**” Current range
  - “**Setting 04**” Clamp sensor
  - “**Setting 05**” VT ratio (if necessary)
  - “**Setting 06**” CT ratio (if necessary)

- Keys

Key		Description
	<b>START/STOP</b> key	No use
	<b>BACKLIGHT</b> key	Switches on/off the backlight of the LCD.
	<b>UP cursor</b> key <b>DOWN cursor</b> key	Changes the display contents. Selects the row to be changed while in custom display mode.
	<b>LEFT cursor</b> key <b>RIGHT cursor</b> key	Changes the display contents. Selects the parameter (V, A etc.) to be displayed while in custom display mode
	<b>ENTER</b> key	Selects/ Enters custom display mode. Confirms the deletion of a file in the internal memory.
	<b>ESC</b> key	Cancels a setting in custom display mode.
	<b>DATA HOLD</b> key	Holds the indicated value on the LCD.
		Pressing this key for at least 2 sec. disables all key operations to prevent operation mistake during a measurement.
	<b>SAVE</b> key	Saves the measured data.

- Indication at no input

When no voltage and current are input, indication on the LCD will be as follows. Refer to “6-5-2 Over-range indication/ Bar indication” in this manual.

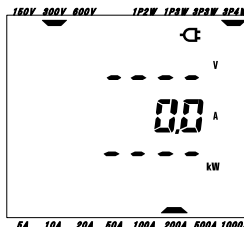

### 6-1 Wiring Configuration display screen

The start-up screens (or the screen after system reset) corresponding to each wiring configuration are listed below.

When turning the Function switch from “OFF” to **W** range, the following measurement screen appears.

e.g. Three-phase 4-wire (Screen 1-A)

Screen 1-A (\*)

		Screen A
Screen 1	Upper	V
	Middle	A
	Lower	P

\* For further details about Screen 1-A, refer to “6-2 Switching the display screen” in this manual.

● Single-phase 2-wire (1ch) “1P2W (1ch)” (9 screens)

		Screen A	Screen B	Screen C	Screen D	Screen E	Screen F	Screen G
Screen 1	Upper	V						
	Middle	A	-	-	-	-	-	-
	Lower	P						
Screen 2	Upper	P						
	Middle	S	-	-	-	-	-	-
	Lower	PF						
Screen 3	Upper	V	A	P	PF	S	Q	f
	Middle	-	-	-	-	-	-	-
	Lower	-	-	-	-	-	-	-

● Single-phase 2-wire (2ch) “1P2W (2ch)” (13 screens)

		Screen A	Screen B	Screen C	Screen D	Screen E	Screen F	Screen G
Screen 1	Upper	V	V	V				
	Middle	A	A1	A2	-	-	-	-
	Lower	P	P1	P2				
Screen 2	Upper	P	P1	P2				
	Middle	S	S1	S2	-	-	-	-
	Lower	PF	PF1	PF2				
Screen 3	Upper	V	A1	P1	PF1	S1	Q1	f
	Middle	-	A2	P2	PF2	S2	Q2	-
	Lower	-	-	-	-	-	-	-



- Single-phase 2-wire (3ch) “1P2W (3ch)”(15 screens)

		Screen A	Screen B	Screen C	Screen D	Screen E	Screen F	Screen G
Screen 1	Upper	V	V	V	V			
	Middle	A	A1	A2	A3	-	-	-
	Lower	P	P1	P2	P3			
Screen 2	Upper	P	P1	P2	P3			
	Middle	S	S1	S2	S3	-	-	-
	Lower	PF	PF1	PF2	PF3			
Screen 3	Upper	V	A1	P1	PF1	S1	Q1	f
	Middle	-	A2	P2	PF2	S2	Q2	-
	Lower	-	A3	P3	PF3	S3	Q3	-

- Single-phase 3-wire “1P3W”, Three-phase 3-wire “3P3W” (13 screens)

		Screen A	Screen B	Screen C	Screen D	Screen E	Screen F	Screen G
Screen 1	Upper	V	V1	V2				
	Middle	A	A1	A2	-	-	-	-
	Lower	P	P1	P2				
Screen 2	Upper	P	P1	P2				
	Middle	S	S1	S2	-	-	-	-
	Lower	PF	PF1	PF2				
Screen 3	Upper	V1	A1	P1	PF1	S1	Q1	f
	Middle	V2	A2	P2	PF2	S2	Q2	-
	Lower	-	-	-	-	-	-	-

- Three-phase 4-wire “3P4W” (15 screens)

		Screen A	Screen B	Screen C	Screen D	Screen E	Screen F	Screen G
Screen 1	Upper	V	V1	V2	V3			
	Middle	A	A1	A2	A3	-	-	-
	Lower	P	P1	P2	P3			
Screen 2	Upper	P	P1	P2	P3			
	Middle	S	S1	S2	S3	-	-	-
	Lower	PF	PF1	PF2	PF3			
Screen 3	Upper	V1	A1	P1	PF1	S1	Q1	f
	Middle	V2	A2	P2	PF2	S2	Q2	In
	Lower	V3	A3	P3	PF3	S3	Q3	-

### NOTE

\* Parameters on each screen can be changed.

Refer to “6-3 Customizing the display” in this manual.

## 6-2 Selecting/changing the display screen

The display screens are classified as follows. Following table is also used in section “6-3 Customizing the display”.



	Screen A	Screen B	Screen C	Screen D	Screen E	Screen F	Screen G
Screen 1	Screen 1-A	Screen 1-B	Screen 1-C	Screen 1-D	—	—	—
Screen 2	Screen 2-A	Screen 2-B	Screen 2-C	Screen 2-D	—	—	—
Screen 3	Screen 3-A	Screen 3-B	Screen 3-C	Screen 3-D	Screen 3-E	Screen 3-F	Screen 3-G

\* In case of single-phase 2-wire (1ch), the following screens do not appear:  
1-B, 1-C, 1-D, 2-B, 2-C, 2-D

\* In case of single-phase 2-wire (2ch), single-phase 3-wire and three-phase 3-wire, the following screens do not appear:  
1-D and 2-D

- Selecting the display screens

Upon turning the Function Switch from “OFF” to **W** range, Screen 1-A is displayed. Use the **Cursor** keys to select other screens.

	Selects from Screen A to G.
	Selects from Screen 1 to 3.

### NOTE

Turning off the instrument or changing the wiring configuration (“**Setting 01**”) on **SET UP** range returns screen 1-A.

• Selecting display screens

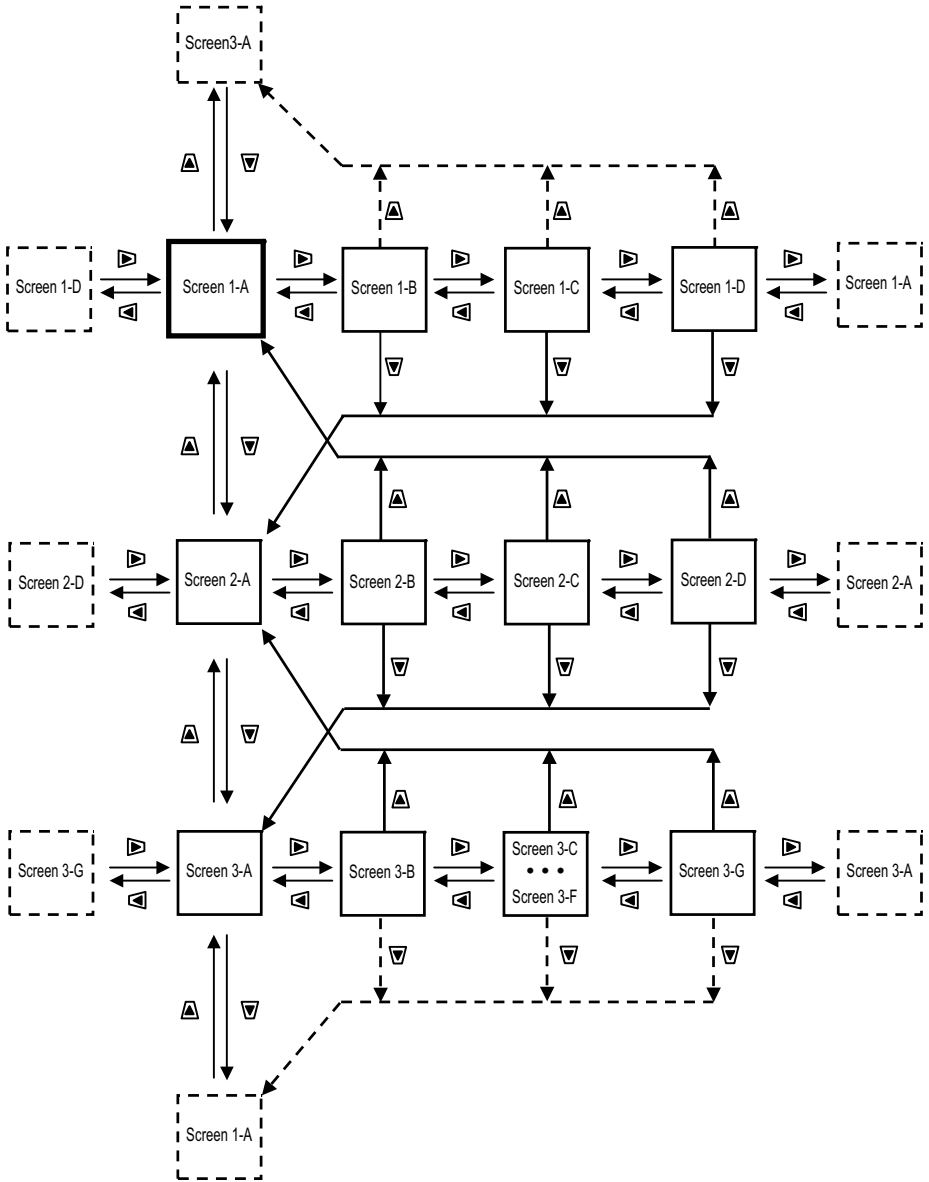

- Display examples

The following are examples of displays with three-phase 4-wire configuration.

Screen 1-A

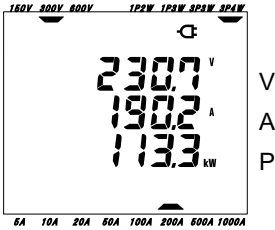

Screen 1-B

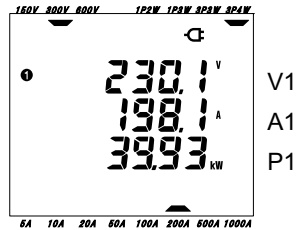

Screen 2-A

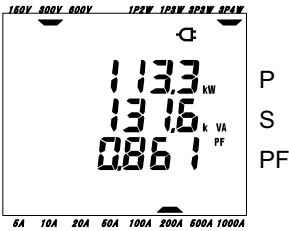

Screen 2-C

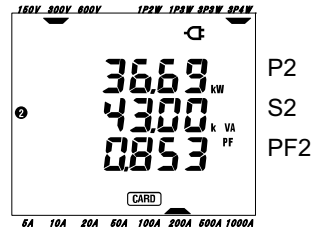

Screen 3-A

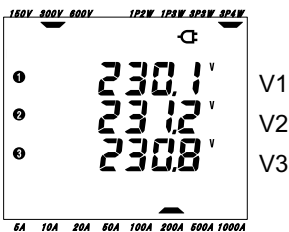

Screen 3-E

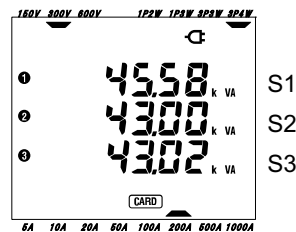

### 6-3 Customizing the display

The displayed parameters in the upper/middle/lower rows of Screen 1 and 2 can be customized. Screen 3 cannot be customized.

- Example

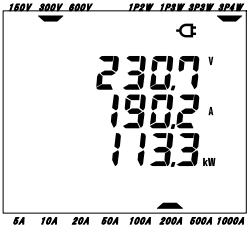
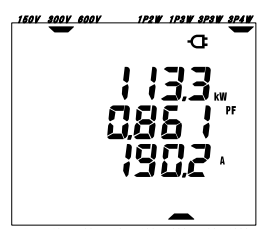
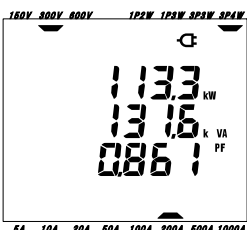
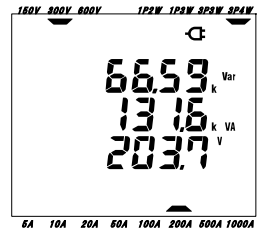
Displayed at:	Before customizing (*)		After customizing
Upper	V : Voltage		P : Active power
Middle	A : Current		PF : Power factor
Lower	P : Active power		A : Current
Screen 1		Example	
			
Upper	P : Active power		Q : Reactive power
Middle	S : Apparent power		S : Apparent power
Lower	PF : Power factor		V : Voltage

\* It is the start up screen or the previously customized screen that is displayed here. After system reset the start up screen is displayed. In the above example, start-up screen is displayed.

- Customizing
  - \* Press the **ENTER** key either on Screen 1 or 2, to enter into custom display mode. Parameter displayed in upper row {eg. initial value: Screen1/ V(Voltage), Screen 2/P(Active power) } will flicker.
  - \* Select the row to be customized using the **UP or DOWN cursor** key and the parameter to be selected with **LEFT or RIGHT cursor** key.
  - \* When customizing other rows, select the row and parameters in same way.
  - \* Select any parameter you want to display it at each row, and press the **ENTER** key.

- Selecting row

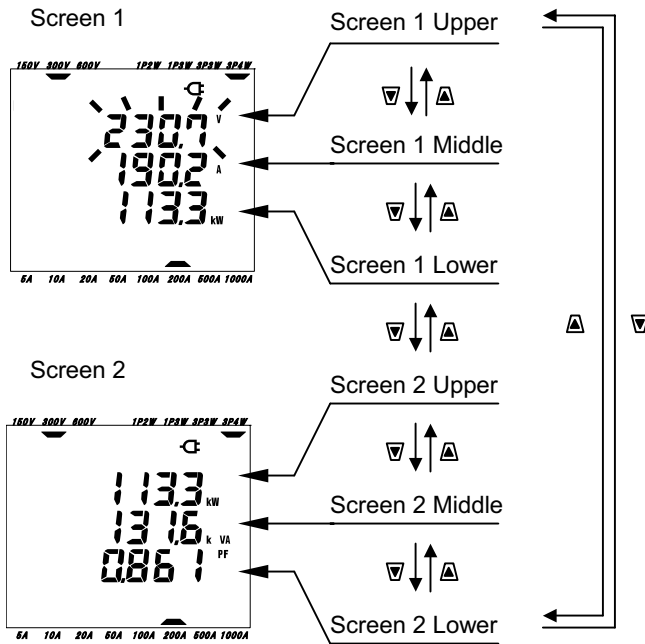

- Selecting parameters

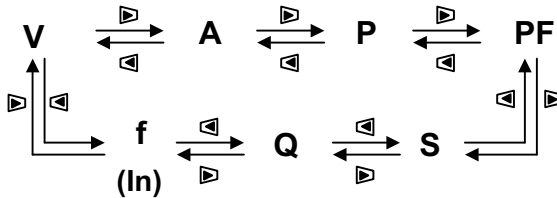

**NOTE**

- \* “f” can be customized only at the upper row, and “In” can be displayed only at the middle row. (when wiring configuration is three-phase 4-wire)
- \* On pressing the **ENTER** key whilst on Screen 3, the instrument will display Screen 1-A custom mode.
- \* Customizing cannot be done during an integration/ demand measurement whilst a survey is underway. This applies also for integration/demand stand by mode.
- \* After system reset, start-up screen appears.
- \* Pressing the **ESC** key during custom display mode restores the original displayed parameters.

### 6-4 Saving data (instantaneous values)

Pressing the **SAVE** key on **W** range during a measurement saves all the measured parameters at the instant of saving. This is a manual single step operation.

Data can be saved to either below two locations:

- \* **CF card** : Max. 20 files can be saved.
- \* **Internal memory** : Only 1 file can be saved.

Data is saved to a CF card automatically when a CF card has been inserted before turning on the instrument. If a CF card has not been inserted, data is automatically saved to internal memory.

#### 6-4-1 Saving Procedure

- \* Press the **SAVE** key whilst on the **W** range .  
**A File is opened.**
- \* The File number screen appears and the instantaneous measured data is saved. (A file number is assigned automatically.)
- \* On the measurement screen, it can be seen that a file is open.

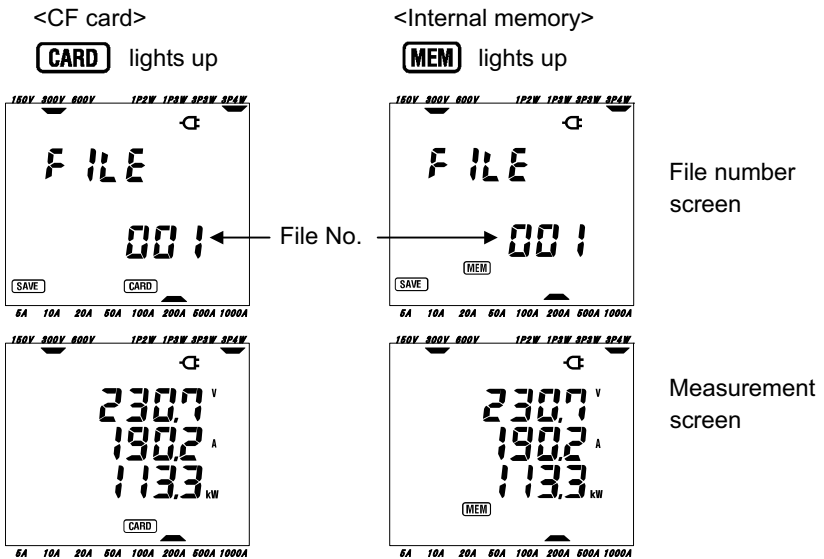



- \* Subsequent measured data can be saved by pressing the **SAVE** key with a file already opened. (**SAVE** is displayed for about 1 sec. to confirm that the data has been saved.)

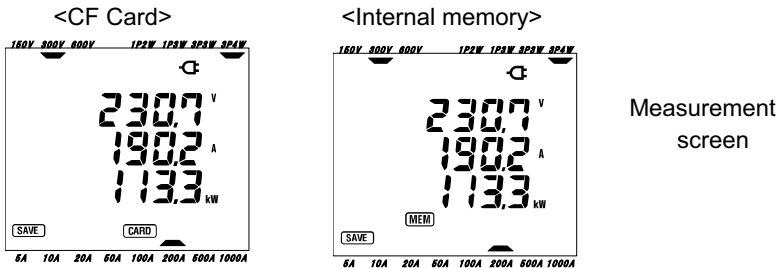

- \* **Closing a file.** On completion of the data gathering, the file has to be closed. Set the Function switch to any range **other than "OFF" and W** (eg. **Wh**). The following screen then appears for 1 second, followed by the screen of the chosen function (eg. **Wh** screen). (in case of CF card is being used, it takes a few seconds.)

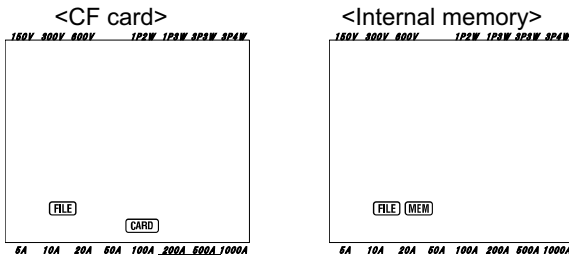

Each time the **SAVE** key is pressed; the measured data is saved in the same file. To save the data into an other file (only when CF card is used), press the **SAVE** key again on **W** range. Then repeat the saving procedure.

#### NOTE

- \* When the Function switch is set to OFF position before closing a file, the file remains open and is not saved. Be sure to set it to any position other than OFF and **W**, thus closing the file.
- \* If the **SAVE** key is pressed continuously (2 times or more in 1sec.), the measured data may not be saved correctly.
- \* The file number becomes "001" when;
  - (1) the file number has exceeded 999
  - (2) after system reset
- \* Data can also be saved to the internal memory even though a card has been inserted. Refer to "**Setting 19**" of Section 4 in this manual.

## 6-4-2 Limitations of saving

Data cannot be saved by pressing the **SAVE** key during a measurement when:

### <CF card>

\* when number of files opened has exceeded 20.

\* when the CF card memory capacity has been exceeded

**FULL** appears and further data cannot be saved. To save further data, previously saved files should be deleted via PC or by deleting all the data in the CF card by using “Setting 21”.(refer to section 4 of this manual)

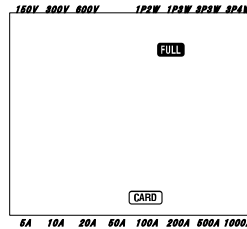
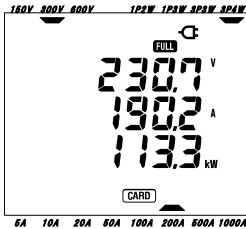

### <Internal memory>

\* when a previously saved file already exist.

( **MEM** appears to indicate there is a file in the internal memory.)

\* when the capacity of internal memory has been exceeded.

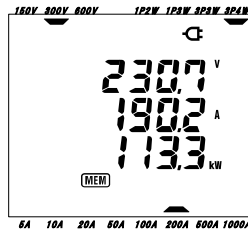

Pressing the **SAVE** key displays a screen prompting the user to delete the file already saved in the internal memory.

To delete the file;

\* The message "dAtA not .dEL" (not deleted) is displayed on the screen.

Press the **Cursor** key and select "dAtA.dEL" (deleted).

\* Then press the **ENTER** key.

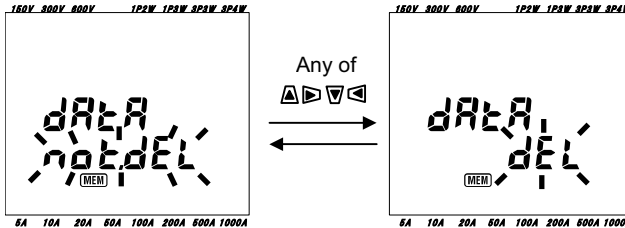

**NOTE**

\* For further details about the capacities of CF card and internal memory, refer to "Section 9: CF card/ Internal memory" in this manual.

**6-4-3 Parameters recorded**

- Parameters Saved (depending on each wiring configuration)  
Following parameters are saved.

Measurement/ calculation parameter	
Voltage (RMS)	Vi : Voltage per phase
Current (RMS)	Ai : Current per phase
Active power	P : Total active power      Pi : Active power per phase
Reactive power	Q : Total reactive power      Qi : Reactive power per phase
Apparent power	S : Total apparent power      Si : Apparent power per phase
Power factor	PF : Power factor of whole system      PFi: Power factor per phase
Frequency	f : Frequency of V1
Neutral current	In : Neutral Current

\* i = 1, 2, 3

• File format and name

Data is saved in CSV format, and the file name is assigned automatically as follows:

File name: 1 FILE 001 . C S V

- 1: Instantaneous value measurement
  - 2: Integration measurement
  - 3: Demand measurement
- FILE : CF card  
DATA : Internal memory
- File number (001 ~ 999)

• Example

After downloading the file (CF card or internal memory), if the file is opened with a spreadsheet application software( using CSV format, eg Microsoft Excel), the spreadsheet will be as follows:

Wiring:	3P4W	←	Wiring	“Setting 01”
Volt Range:	300V	←	Voltage range	“Setting 02”
Current Range:	200A	←	Current range	“Setting 03”
Sensor Type:	500A	←	Clamp sensor	“Setting 04”
VT ratio:	1	←	VT ratio	“Setting 05”
CT ratio:	1	←	CT ratio	“Setting 06”

	DATE	TIME	V1	V2	V3	A1	A2	A3	P	P1	P2	P3
* 1	2004/3/21	15:50:35										
* 2	2004/3/21	16:51:21										
* n	⋮	⋮	⋮	⋮	⋮	⋮	⋮	⋮	⋮	⋮	⋮	⋮

PF	PF1	PF2	PF3	S	S1	S2	S3	Q	Q1	Q2	Q3	f	In

- \*1: this is the data saved when **SAVE** key is pressed for the first time. (i.e. when a file is opened).
  - \*2: this is the second data point saved when the **SAVE** key is pressed again whilst the file is still open.
  - \*n: these are subsequent data points saved whenever the **SAVE** key is pressed whilst the file is still open.
- Data will be displayed in exponential format. (e.g. when V1 is 100.1V, “1.001E+2”).

## 6-5 Ranges and Over-range indication

### 6-5-1 Ranges

The settings determine the range for each measurement parameter, namely:

Voltage range ("**Setting 02**"), Current range ("**Setting03**"), VT ratio ("**Setting 05**") and CT ratio ("**Setting 06**"). (Fixed range)

- **Voltage V:** V(average of each phase), V1/V2/V3 (each phase), max 4 digits  
150/300/600V range

Voltage range x VT ratio x 120%	Digit & Decimal point position
180 ~ 999.9 V	999.9 V
1k ~ 9.999 kV	9.999 kV
10k ~ 99.99 kV	99.99 kV
100k ~ 999.9 kV	999.9 kV
1M ~ 7.2 MV	7.200 MV

When the value of (Voltage range x VT ratio x 120%) exceeds 9999, the decimal point moves one place to the right.

- **Current A:** A(average of each phase), A1/A2/A3 (each phase), max 4 digits  
50A Clamp sensor : 5 / 10 / 20 / 50A range  
100AClamp sensor : 10 / 20 / 50 / 100A range  
200AClamp sensor : 20 / 50 / 100 / 200A range  
500AClamp sensor : 50 / 100 / 200 / 500A range  
1000AClamp sensor : 100 / 200 / 500 / 1000A range  
3000AClamp sensor : 1000 / 3000A range

Current range x CT ratio x 120%	Digit & Decimal point position
6 ~ 9.999 A	9.999 A
10 ~ 99.99 A	99.99 A
100 ~ 999.9 A	999.9 A
1k ~ 9.999 kA	9.999 kA
10k ~ 99.99 kA	99.99 kA
100k ~ 999.9 kA	999.9 kA
1M ~ 9.999 MA	9.999 MA
12 MA	12.00 MA

When the value of (Current range x CT ratio x 120%) exceeds 9999, the decimal point moves one place to the right.

● **Active power P/ Reactive power Q/ Apparent power S**

: P1/P2/P3, Q1/Q2/Q3, S1/S2/S3 , max 4 digits

: P, Q, S (total), max 5 digits

Power (*) x VT ratio x CT ratio x 120%	Digit & Decimal point position
900 ~ 999.9 W/Var/VA	999.9 W/Var/VA
1k ~ 9.999k W/Var/VA	9.999 k W/Var/VA
10k ~ 99.99k W/Var/VA	99.99 k W/Var/VA
100k ~ 999.9k W/Var/VA	999.9 k W/Var/VA
1M ~ 9.999M W/Var/VA	9.999 M W/Var/VA
10M ~ 99.99M W/Var/VA	99.99 M W/Var/VA
100M ~ 999.9M W/Var/VA	999.9 M W/Var/VA
1G ~ 9.999G W/Var/VA	9.999 G W/Var/VA
10G ~ 99.99G W/Var/VA	99.99 G W/Var/VA
100G ~ 999.9G W/Var/VA	999.9 G W/Var/VA
1000G ~ 9999 G W/Var/VA	9999 G W/Var/VA

\* The table shows values of power corresponding to each voltage and current range.

Voltage range	Current range							
	5.000A	10.00A	20.00A	50.00A	100.0A	200.0A	500.0A	1000A
150.0V	750.0	1.500k	3.000k	7.500k	15.00k	30.00k	75.00k	150.0k
300.0V	1.500k	3.000k	6.000k	15.00k	30.00k	60.00k	150.0k	300.0k
600.0V	3.000k	6.000k	12.00k	30.00k	60.00k	120.0k	300.0k	600.0k

The above listed power values apply to single-phase 2-wire(1ch).The power for a single-phase 2-wire(2ch)/single-phase 3-wire/ three-phase 3-wire system will be twice that of the above values. Total power of the individual phases of a single-phase 2-wire(3ch)/ three-phase 4-wire system will be three times that of the above values.

● **Power factor PF:** PF (whole system), PF1/PF2/PF3 (each phase), 4 digits

Display range
-1.000 ~ 1.000 PF

● **Frequency f:** 3 digits

Display range
40.0 ~ 70.0 Hz

● **Neutral current In (A)** (only for three-phase 4-wire system): max 5 digits  
 Decimal point and the unit are same as for **Current**.

## 6-5-2 Over-range indication/ Bar indication

### WARNING

- When the over-range indication appears on the maximum chosen range, this means that the input exceeds the maximum allowable input for the instrument. Never apply such an input to the instrument.
- When a measured value exceeds the maximum allowable input, the use of VT/CT's is recommended. Refer to "5-3 VT/ CT" and follow the instruction manual.

### CAUTION

- When over-range indication appears on the screen, calculations are still performed. However their accuracy may not be guaranteed.

- Over-range indication

The Over-range indication appears when the parameters (Voltage V, Current A, Active power P, Reactive power Q, Apparent power S) exceed the following condition.

- \* Voltage V (V):  $> \text{Voltage range selected} \times \text{VT ratio} \times 120\%$   
(e.g.: when voltage range is 300V and VT ratio is 1: 360.0V)
- \* Current A (A):  $> \text{Current range} \times \text{CT ratio} \times 120\%$   
(e.g.: when current range selected is 200A and CT ratio is 2: 480.0A)
- \* Active power P (W)/ Reactive power Q (Var)/ Apparent power S (VA)  
:  $> \text{Power} \times \text{VT ratio} \times \text{CT ratio} \times 120\%$   
(e.g.: when power is 60kW, VT ratio is 1 and CT ratio is 2: 144.0kW)

<  indication >

When any of the above conditions are met, "

<  mark >

When "

< **AOL** mark >

When “**OL**” appears for over-range indication for any of A1, A2 and A3, this is displayed on the LCD. In this case, **AOL** mark appears on all measurement screens on the **W** position.

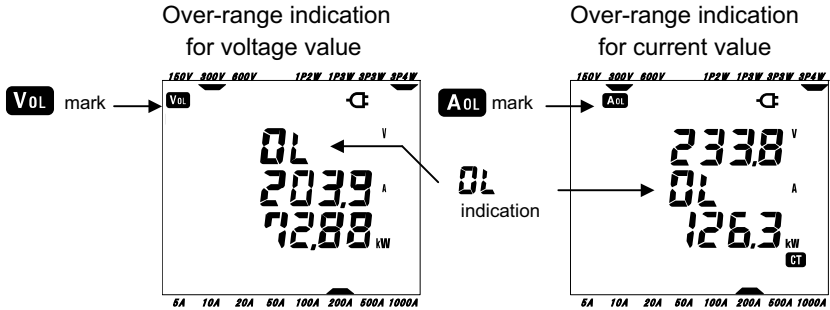

• Bar indication

The calculations and measurements performed by this instrument are based on the voltage and frequency of V1. If the value of V1 is less than 5% of the chosen range or if the frequency is not within 40 ~ 70Hz, all the parameters (except for current ) cannot be computed and thus displayed. In such a case, the numerical digits will be replaced by a bar indication (“- - -”) as shown:

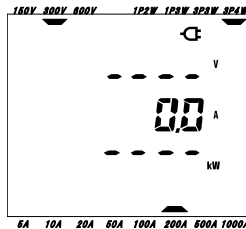

NOTE:

- \* **V0L** or **AOL** mark is displayed every measurement screen while a measurement is performed on **Wh** or **DEMAND** range.



## 7. Integration value measurement

Set the Function switch to **Wh** range.

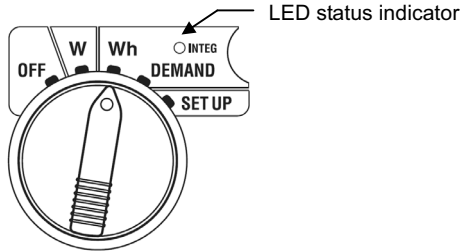

If the Function switch is set to the any other position during integration measurement or stand-by mode, the following happens;

- W** range : Confirms instantaneous values.  
(see “**Section 6: Instantaneous value measurement**”)
- DEMAND** range : No effect
- SET UP** range : Confirms the settings.  
(see “**Section 4: Settings**”)

### • Indications

Measurement/Calculation Parameter		Unit
Active electrical energy (consumption)	WP : Total active electrical energy	Wh
	WP1/WP2/WP3 : Active electrical energy per phase	
Apparent electrical energy (consumption)	WS : Total apparent electrical energy	VAh
	WS1/WS2/WS3 : Apparent electrical energy per phase	
Elapsed time of integration	TIME : Hour; Min.; Sec. Hour; Min. Hour	-

### NOTE:

- \* The above parameters vary depending on each wiring configuration.
- \* If V1 is out of measuring range, other parameters may not be measured or calculated.
- \* Only the consumed electrical energy is displayed on the screen. Regenerative energy will only be saved. Refer to “**7-5-3 Saving data**” in this manual.
- \* Displayed time changes with the elapsed time of integration.

- Prior to making a measurement

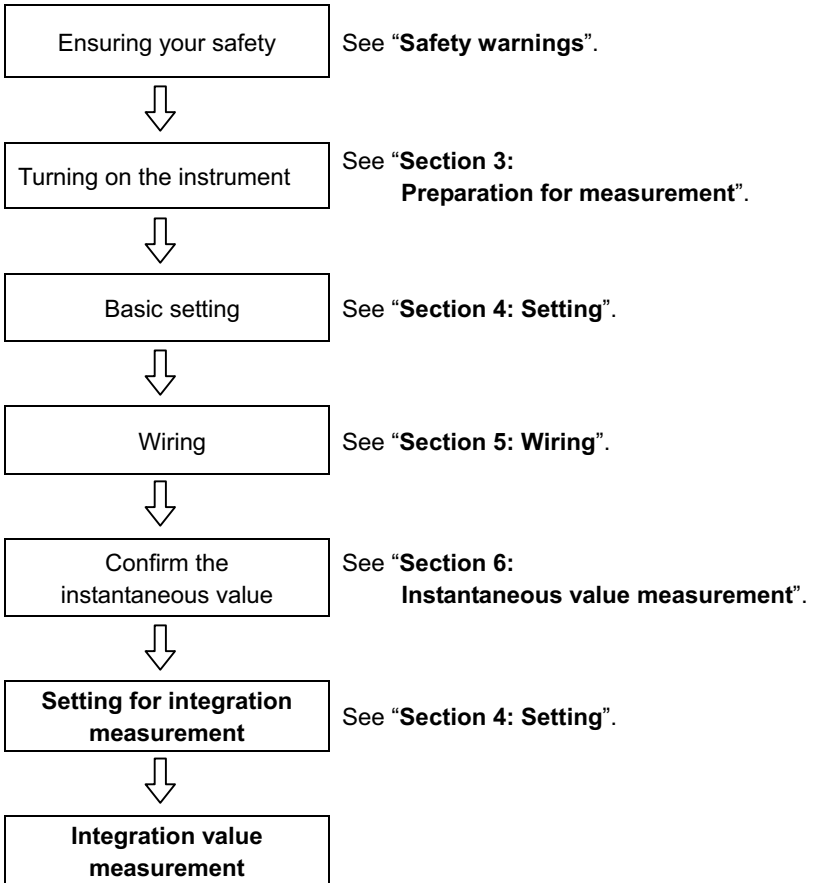

- Settings for integration measurement

Apart from basic settings the following settings are required for integration measurement.









“**Setting 09**” Integration interval

“**Setting 10**” Integration start time & date (measurement starts at set time & date)

“**Setting 11**” Integration stop time & date (measurement stops at set time & date)

“**Setting 12**” Reset of integration value

- Keys

Key		Description
	<b>START/STOP</b> key	Pressing this key starts/stops integration measurement manually or automatically.
	<b>BACKLIGHT</b> key	Switches on/off the backlight of the LCD.
	<b>UP cursor</b> key <b>DOWN cursor</b> key	Changes the display contents.
	<b>LEFT cursor</b> key <b>RIGHT cursor</b> key	Changes the display contents.
	<b>ENTER</b> key	Resets the integration value. Confirms the deletion of a file in the internal memory.
	<b>ESC</b> key	Resets the integration value.
	<b>DATA HOLD</b> key	Holds the indicated value on the LCD.
		Pressing this key for at least 2 sec. disables all key operations to prevent operation mistake during a measurement.
	<b>SAVE</b> key	No use

**NOTE:**

\* Data hold function is disabled while the instrument is in stand-by mode for integration measurement.

### 7-1 Survey initiation

There are two ways of starting a survey.

(1) Manual operation

Pressing **START/STOP** key on **Wh** range for 2 sec. or more starts measurement.

(2) Automatic operation (presetting the time and date)

Set the start time and date on the **SET UP** range (“**Setting 10**”), and then press **START/STOP** key on **Wh** range. The instrument goes into stand-by mode, and the measurement starts at the preset time and date.

● **Manual measurement**

\* Press the **START/STOP** key on **Wh** range for 2 secs. or more.

\* The file number screen is displayed for about 2 sec. (a file is opened), followed by the measurement screen. The survey then starts.

At this time, LED status indicator is on. In addition, **INTEG** and **CARD** (\*\*)  
marks appear on the measurement screen.

(\*\*) When data is to be saved to the CF Card, **CARD** mark appears. When data is to be saved to the internal memory, **MEM** mark appears.

(See “**Setting19**”).

File number screen  
(displayed for about 2 sec.)



Measurement screen

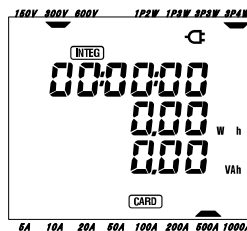

LED status indicator is on.

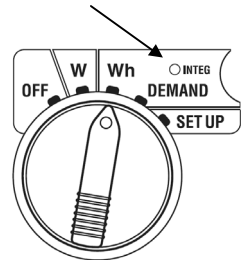

- **Automatic** measurement at a preset time and date  
Preset the start time and date on **SET UP** range.

- \* Preset the start time and date on **SET UP** range. (“**Setting 10**”)
- \* Set the Function switch to **Wh** range, and press the **START/STOP** key.
- \* The file number screen is displayed for about 2 sec. (a file is opened), followed by the measurement screen. The instrument goes into stand-by mode. LED status indicator and **INTEG** mark flicker while the instrument is in stand-by mode.

File number screen  
(displayed for about 2 sec.)

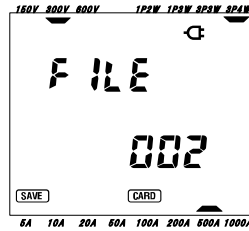

Measurement screen

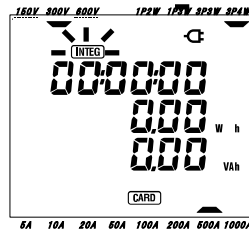

LED status indicator  
flickers

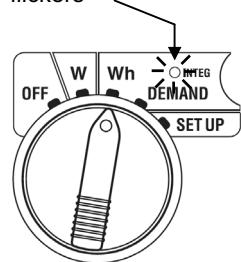

- \* If CF card is present, the CF card( **CARD** ) mark; otherwise the internal memory ( **MEM** ) mark appears on the File number screen and measurement screen. (See “**Setting19**”.)
- \* The survey starts at the preset time and date, and the **INTEG** mark and the LED status indicator stop flickering and are permanently on.

**NOTE:**

- \* **INTEG** mark is displayed on the **W** and **DEMAND** range, while the instrument is performing measurement.
- \* The start time and date should be set after the current time in such a way to give enough time to the user to complete all settings before the survey starts.
- \* When the start time and date are set before the current time, measurement starts immediately upon pressing the **START/STOP** key.
- \* If the preset start time and date come after the preset stop time and date, the survey cannot be done.
- \* Even if the start and stop time have been preset and the instrument is in standby mode, pressing the **START/STOP** key at least 2 sec. releases the stand-by mode and start a survey in Manual mode. This renders the start/ stop time and date settings ineffective.

Then **INTEG** , **CARD** (or **MEM** ) marks disappear and the LED status indicator goes off.

## 7-2 Survey closure

There are two ways of closing a survey.

### (1) Manual operation

Pressing **START/STOP** key on **Wh** range for 2 sec. or more closes the survey. This action also closes a survey started automatically at a preset time and date. Upon survey closure the **INTEG**, **CARD** (when CF card is present) marks disappear and the LED status indicator goes off.

### (2) Automatic operation (presetting the time and date)

This can be done by presetting the stop time and date on **SET UP** range ("Setting 11"). This method is available only when the survey is started at the preset time and date. When the preset time and date have been reached, **INTEG**, **CARD** (when CF card is present) marks disappear and LED status indicator goes off. The survey is then closed.

When a survey is closed manually or automatically, **FILE** mark appears for 1 sec. This confirms that the file opened at the start of the survey has been closed.

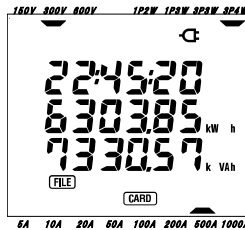

## NOTE

\* When data is saved to the internal memory, **MEM** mark remains on. (indicating that a file exists in the internal memory)

- \* A survey will be closed and lost when the instrument is switched off.
- \* Manually starting a survey renders a preset stop time and date ineffective. The survey has to be closed manually in this case.
- \* If the survey duration is shorter than the integration interval (“**Setting 09**”) the measured data will not be saved.
- \* If the preset start time and date come after the preset stop time and date, the survey cannot be done.
- \* Pressing the **START/STOP** key 2 sec. or more releases the stand-by mode. The **INTEG** , **CARD** (or **MEM** ) marks disappear and LED status indicator goes off.



### 7-3 Resetting the integration value

There are three methods for resetting the integration value and period from previous measurements.

- a) Press **ESC** key on **Wh** range 2 sec. or more.  
 Press **ESC** key on **Wh** range 2 sec. or more. Then a message "oFF" (not reset) flickers. Select "on" (reset) with the **Cursor** key, and press the **ENTER** key. The previous integration value and period will be reset.

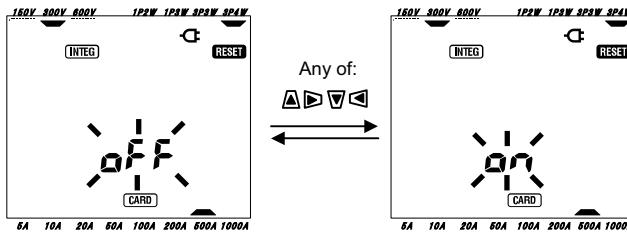

- b) Reset the integration value at "Setting 12".  
 c) System reset

#### NOTE

\* Integration value cannot be reset during a measurement or while the instrument is in stand-by mode.

### 7-4 Changing displays

Displays can be changed as follows with the **Cursor** keys. The parameters displayed vary depending on each wiring configuration chosen. Each calculated parameter, although not displayed on the screen, is actually being computed.

- Changing the display (Three-phase 4-wire configuration)

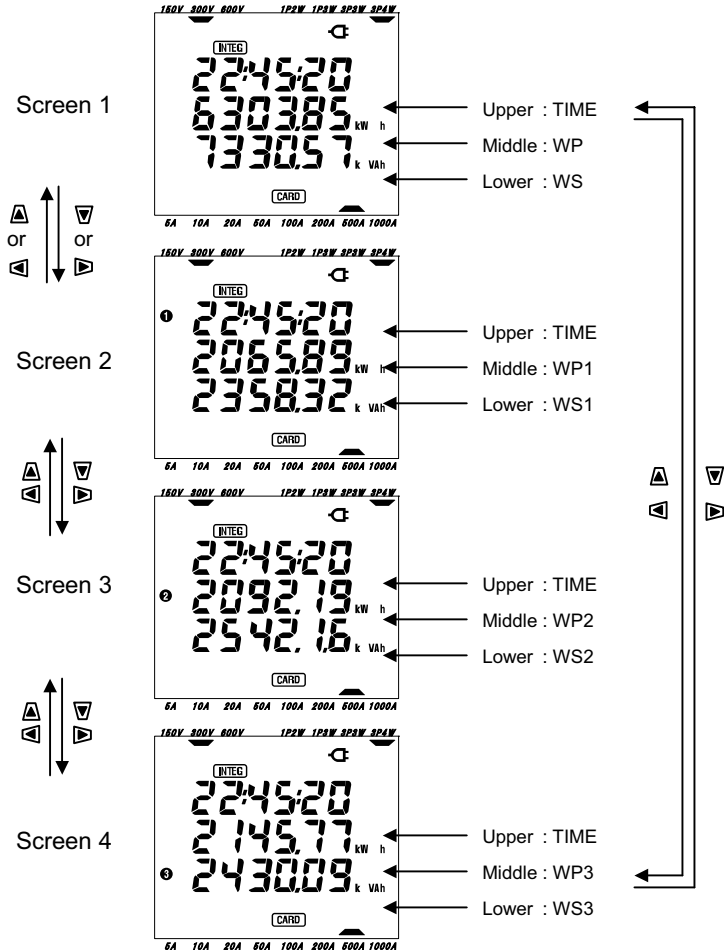

Section 7

- Indications on each wiring configuration

The following messages are displayed on the screen according to each wiring configuration.

Wiring ("Setting 01")	Displayed at	Displayed contents			
		Screen1	Screen2	Screen3	Screen4
1P2W (1ch)	Upper	TIME			
	Middle	WP	-	-	-
	Lower	WS			
1P2W (2ch) 1P3W 3P3W	Upper	TIME	TIME	TIME	
	Middle	WP	WP1	WP2	-
	Lower	WS	WS1	WS2	
1P2W (3ch) 3P4W	Upper	TIME	TIME	TIME	TIME
	Middle	WP	WP1	WP2	WP3
	Lower	WS	WS1	WS2	WS3

Legend:

TIME : Elapsed time of integration

WP : Total active electrical energy

WP1/WP2/WP3 : Active electrical energy per phase

WS : Total apparent electrical energy

WS1/WS2/WS3 : Apparent electrical energy per phase

## 7-5 Saving data

When integration or demand measurement starts, the measured data will be saved automatically.

There are two locations where data can be saved.

\* **CF card** : **Max. 20 files can be saved.**

\* **Internal memory** : **Only 1 file can be saved.**

Data is saved to a CF card automatically when a CF card has been inserted before turning on the instrument. If the CF card has not been inserted, data is saved automatically to internal memory.

### 7-5-1 Saving Procedure

\* When a survey is started (manually or automatically) a file is opened.

\* Data is saved at the end of each integration interval ("**Setting 09**").

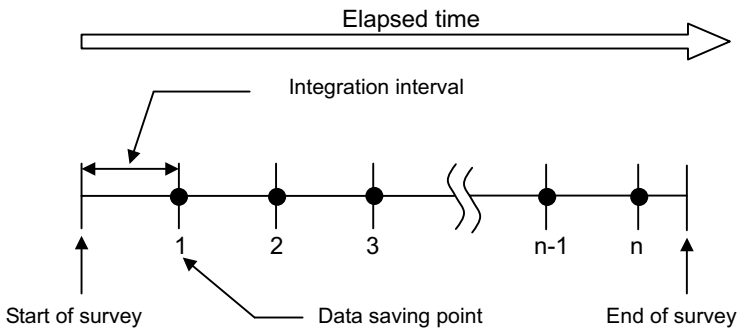

\* When the survey is closed (manually or automatically) the file is closed

\* All the recorded parameters at each data saving point are saved to one file.

### NOTE

\* Never set the Function switch to OFF position during a survey otherwise the survey may be lost.

\* The file number becomes "001" when;

(1) when the file number has exceeded 999

(2) after system reset

\* Data can also be saved to the internal memory even though a card has been inserted. Refer to "**Setting 19**" of Section 4 in this manual.

### 7-5-2 Limitations of saving

- Limitation of saving (before starting a survey)

In the following cases, a survey cannot be started (manually or automatically) by pressing the **START/STOP** key.

< In case data is saved to CF card >

- \* When 20 files have been saved to the CF card; **FULL** mark appears and further data cannot be saved.

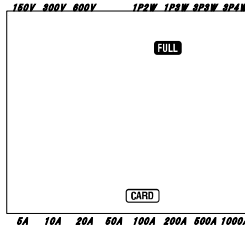

Some files can to be deleted via the PC, otherwise all the saved files in the CF card can be deleted using “**Setting 21**” of Section 4 in this manual.

< In case the data is saved to internal memory >

When previous saved data exists

- \* **MEM** mark is displayed on the LCD to indicate that there is a file in the internal memory.

Pressing the **START/STOP** key displays a screen prompting the user delete the file already saved in the internal memory.

To delete the file;

- \* The message “**dAtA not .dEL**” (not delete) is displayed on the screen.

Press the **Cursor** key and select “**dAtA.dEL**” (delete).

- \* Then press the **ENTER** key.

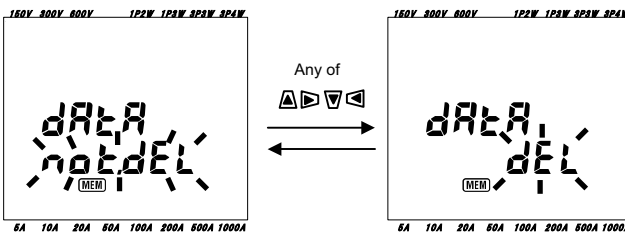

For manual operation, the survey starts upon deleting the data in the internal memory. When start time and date have been preset, the instrument goes into stand-by mode.

- Limitations of saving (during a survey)

When the capacity of CF card or internal memory has been exceeded during a survey; measurement continues but **FULL** mark appears on the display screen and further data will not be saved.

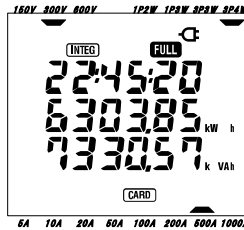

Press the **START/STOP** key 2 sec. or more and stop the survey once. Refer to preceding page and delete the unnecessary file.

#### NOTE

- \* If the function switch is set to OFF before the closure of a survey, the measured data may be lost.
- \* For further details about the capacity of the CF card and internal memory, refer to “**Section 9: CF card/ Internal memory**” in this manual.

### 7-5-3 Parameters Recorded

Depending on the wiring configuration chosen, the following parameters are recorded:

Parameters recorded(measured or computed)	
Voltage (RMS)	Vi : Instantaneous value of phase i at end of interval Vi max : Max. value of phase i during interval Vi avg : Average value of phase i during interval
Current (RMS)	Ai : Inst value of phase i at end of interval Ai max : Max. value of phase i during interval Ai avg : Average value of phase i during interval
Active power	P : Inst value of total active power at end of interval P max : Max. value of P during interval P avg : Average value of P during interval Pi : Instantaneous value of phase i at end of interval Pi max : Max. value of phase i during interval Pi avg : Average value of phase i during interval
Reactive power	Q : Inst value of total reactive power at end of interval Q max : Max. value of Q during interval Q avg : Average value of Q during interval Qi : Instantaneous value of phase i at end of interval Qi max : Max. value of phase i during interval Qi avg : Average value of phase i during interval
Apparent power	S : Inst value of total apparent power at end of interval S max : Max. value of S during interval S avg : Average value of S during interval Si : Instantaneous value of phase i at end of interval Si max : Max. value of phase i during interval Si avg : Average value of phase i during interval
Power factor	PF : Inst value of Power factor of whole system at end of interval PF max : Max. value of PF during interval PF avg : Average value of PF during interval Pfi : Instantaneous value of phase i at end of interval Pfi max : Max. value of phase i during interval Pfi avg : Average value of phase i during interval
Frequency	f : Inst value of Frequency of V1 at end of interval f max : Max. value of f during the interval f avg : Average value of f during the interval
Neutral current	In : Current on neutral conductor at end of interval In max : Max. value of In during the interval In avg : Average value of In during the interval
Active electrical energy (consumption)	+WP : Total active electrical energy(consumption) +WPi : Active electrical energy per phase (consumption)
Active electrical energy (regenerating)	-WP : Total active electrical energy (regenerating) -WPi : Active electrical energy per phase (regenerating)
Active electrical energy (overall)	#WP : Total active electrical energy(overall) #WPi : Active electrical energy per phase(overall) during interval

Apparent electrical energy (consumption)	+WS : Total apparent electrical energy (consumption) during interval +WSi : Apparent electrical energy per phase (consumption)
Apparent electrical energy (regenerating)	-WS : Total apparent electrical energy (regenerating) during interval -WSi : Apparent electrical energy per phase (regenerating)
Apparent electrical energy (overall)	#WS : Total apparent electrical energy(overall) during interval #WSi : Apparent electrical energy per phase(overall)
Reactive electrical energy (consumption)	+WQ : Total reactive electrical energy (consumption) during interval +Wqi : Reactive electrical energy per phase (consumption)

\* i = 1, 2, 3

\* max, avg mean max value and average value during an interval.

• File format and name

Measured data is saved in CSV format, and the file name is assigned automatically.

File name: 2 FILE 001 . C S V

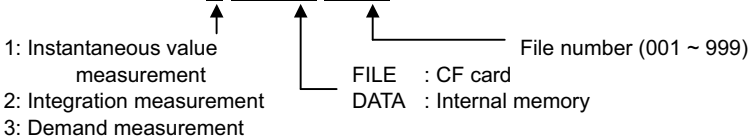



● Example of measured data

Wiring:	3P4W	← Wiring	"Setting 01"
Volt Range:	300V	← Voltage range	"Setting 02"
Current Range:	500A	← Current range	"Setting 03"
Sensor Type:	500A	← Clamp sensor	"Setting 04"
VT ratio:	1	← VT ratio	"Setting 05"
CT ratio:	1	← CT ratio	"Setting 06"
Interval	30min	← Integration interval	"Setting 09"
START	2004/03/22_08:30:00	← Integration start time and date	

	DATE	TIME	ELAPSED TIME	V1	V2	V3	Q3	f	In
1	2004/03/22	09:00:00	00000:30:00						
2	2004/03/22	09:30:00	00001:00:00						
n									

V1	V2	V3	Q3	F	In	V1	V2	V3	Q3	F	In
max	max	max	max	max	max	avg	avg	avg	avg	avg	avg

+	+	+	-	#	#	#	#	+	#	#	+
WP	WP1	WP2	WP3	WP	WP1	WP2	WP3	WS	WS2	WS3	WQ

Data will be displayed in exponential format. (e.g. 38672.1kWh, "3.86721E+7").

**7-6 Displayed Digits/ Over-range indication**

● Digits

\* **Active electrical energy WP, Apparent electrical energy WS** (auto-range)

: WP1/WP2/WP3, WS1/WS2/WS3 (each phase), max 6 digits

: WP, WS (total), max 6 digits

The range is automatically assigned depending on the measured value.  
 The decimal point and unit are changed automatically.

Unit: Wh/ VAh	
0.00	~ 9999.99
10000.0	~ 99999.9
100000	~ 999999
1000.00 k	~ 9999.99 k
10000.0 k	~ 99999.9 k
100000 k	~ 999999 k
1000.00 M	~ 9999.99 M
10000.0 M	~ 99999.9 M
100000 M	~ 999999 M
1000.00 G	~ 9999.99 G
10000.0 G	~ 99999.9 G
100000 G	~ 999999 G

When the value exceeds 999999G, segment becomes "OL".  
 However the saved data is not lost.

**\* Elapsed time TIME**

Displayed time changes with time as follows.

Elapsed time	
00:00:00 ~ 99:59:59	hour: minute: second
100:00 ~ 9999:59	hour: minute
10000 ~ 999999	hour

● Over-range indication/ others

\* When the input voltage and the current exceeds the max display counts, **VoL** or **AoL** mark is displayed on the LCD. In this case, accurate measurement cannot be made.

\* On the **W** range, when the P (active power) is shown by bars " - - - ", this means that the increment in electrical energy is insignificant. Refer to "6-5-2 Over-range indication/ Bar indication" in this manual.

## 8. Demand value measurement

Set the Function switch to **DEMAND** range.

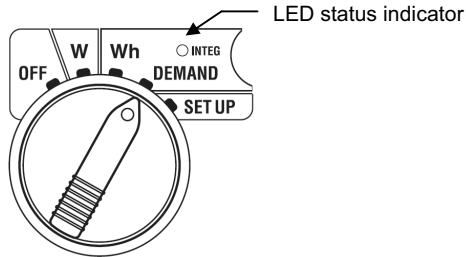

If the Function switch is set in the following positions during Demand measurement or Demand stand-by mode;

- W** range : The instantaneous values are displayed.  
(see “**Section 6: Instantaneous value measurement**”)
- Wh** range : The instantaneous values are displayed.  
(see “**Section 7: Integration value measurement**”)
- SET UP** range : The settings are displayed.  
(see “**Section 4: Settings**”)

### ● Indications

Measurement/Calculation items	Unit
Target demand value	W
Predicted demand value	W
Present demand value	W
Load factor	%
Remaining time for demand interval elapse	-
Max. demand value recorded so far	W
Date and time when max. demand value was recorded	-

- Before making a measurement

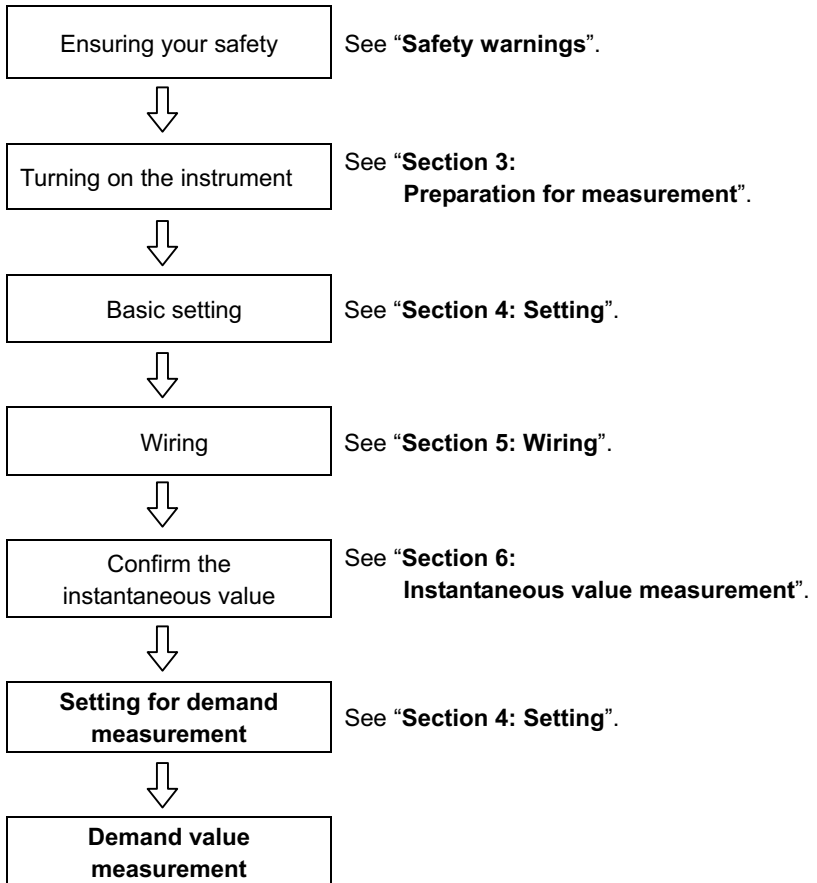

- Settings only for demand measurement

Basic setting and following settings are required for demand measurement.

“**Setting 13**” Demand interval

“**Setting 14**” Demand start time & date (measurement starts at setting time & date)









“**Setting 15**” Demand stop time & date (measurement stops at setting time & date)

“**Setting 16**” Demand target value

“**Setting 17**” Demand inspection cycle

“**Setting 18**” Reset of demand value

- Keys

Key		Description
	<b>START/STOP</b> key	Pressing this key starts/stops demand measurement manually or automatically.
	<b>BACKLIGHT</b> key	Switches on/off the backlight of the LCD.
	<b>UP cursor</b> key <b>DOWN cursor</b> key	Changes the display contents.
	<b>LEFT cursor</b> key <b>RIGHT cursor</b> key	Changes the display contents.
	<b>ENTER</b> key	Resets the demand value. Confirms the deletion of a file in the internal memory.
	<b>ESC</b> key	Resets the demand value.
	<b>DATA HOLD</b> key	Holds the indicated values on the LCD.
		Pressing this key for at least 2 sec. locks all key operations to prevent measurement interruption
	<b>SAVE</b> key	No use

**NOTE**

\* Data hold function is disabled while the instrument is in stand-by mode for demand measurement.

**8-1 Demand measurement**

The following is an example of power management by monitoring the demand.

- Reducing the average power during a specific interval

Assume the interval to be 30mins.

In the figure below, the average power during Interval 1 is assumed to be 500kW and during Interval 2 is assumed to be 600kW.

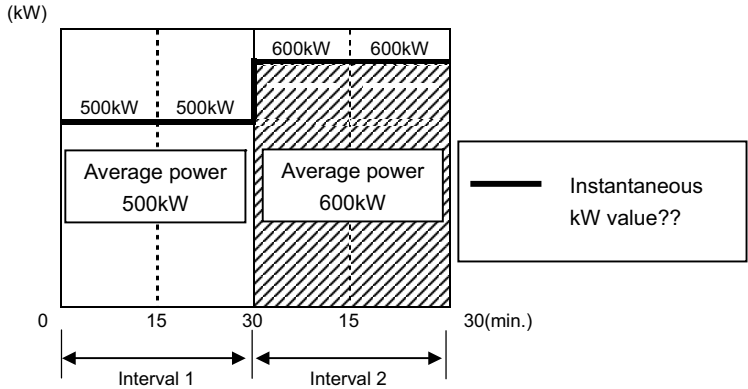

Now, assume that the average power during the first 15 min. (the inspection cycle) of Interval 2 is 600kW. The average power during Interval 2 can be maintained at 500kW (same as Interval 1) by reducing the power of the last 15 min. to 400kW.

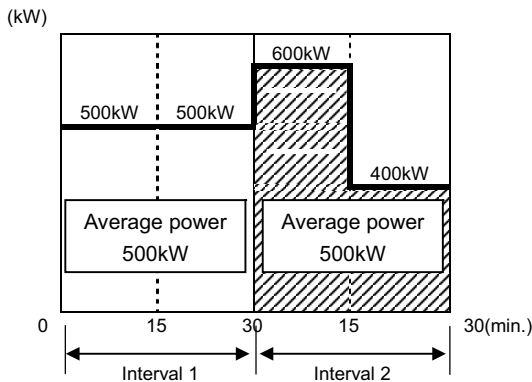

If say, the average power during the first 15 min. is 1000kW then the average power during the second 15min should be 0kW to maintain an average power of 500kW.

● Demand measurement with this instrument

By measuring loads, the MODEL6300 can display the present and predicted average power(demand value). These values are continuously updated as time elapses during a particular interval.

The buzzer will sound and the backlight will flash when a predicted demand value exceeds a target demand value after the elapse of the preset inspection cycle.

The value which is displayed at the end of an interval (in this case, 30 min.) is the average power (**Demand value**) for the interval.

The figure below describes the relationship between: **Target demand value, Predicted value, Present demand value, interval and inspection cycle**

What do the 400 and 600kW below indicate? The horizontal axis is a time scale and not power scale. Are they the predicted demand value displayed?

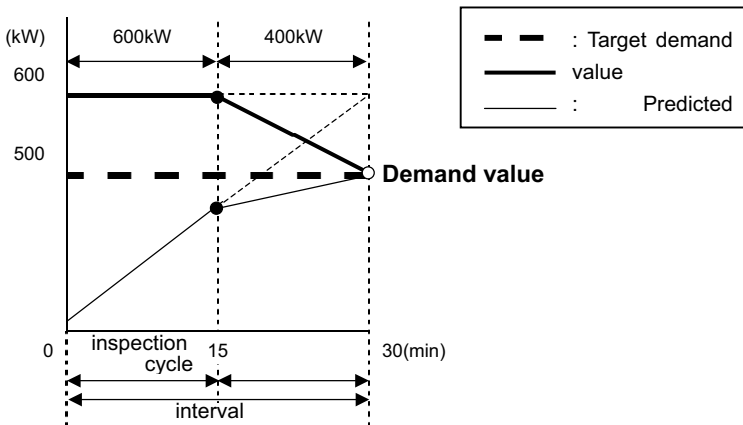

\* In this case, the demand value at the end of the interval is 500kW.

The demand values calculated at each interval are useful for power management per day, month or year.

**NOTE**

\* The readings of the demand meter installed by the power company and the MODEL6300, may not match completely due to a time-lag in the start of intervals.

- Settings required for Demand measurement

Interval : **“Setting 13”** Demand interval

Target demand value : **“Setting 16”** Demand target value

Inspection cycle : **“Setting 17”** Demand inspection cycle

Buzzer : **“Setting 07”** Buzzer

To start/stop measurement at a preset time and date, the following settings are also required:

\* Measurement start: **“Setting 14”**: Demand start time and date

\* Measurement stop: **“Setting 15”**: Demand stop time and date

Refer to section **“8-3 Starting a measurement”** and section **“8-4 Stopping measurement”** in this manual.

- Saving Demand values

When one demand measurement (demand interval) ends, demand values are saved to the CF card or the internal memory.

Refer to **“8-6 Saving data”** in this manual. After the data is saved, the next demand measurement starts.

The max. demand value is displayed on the LCD together with the corresponding time and date.

The following is an example of the saving status of a demand value survey where the demand interval is 30 min and the survey duration is about 3 hours.

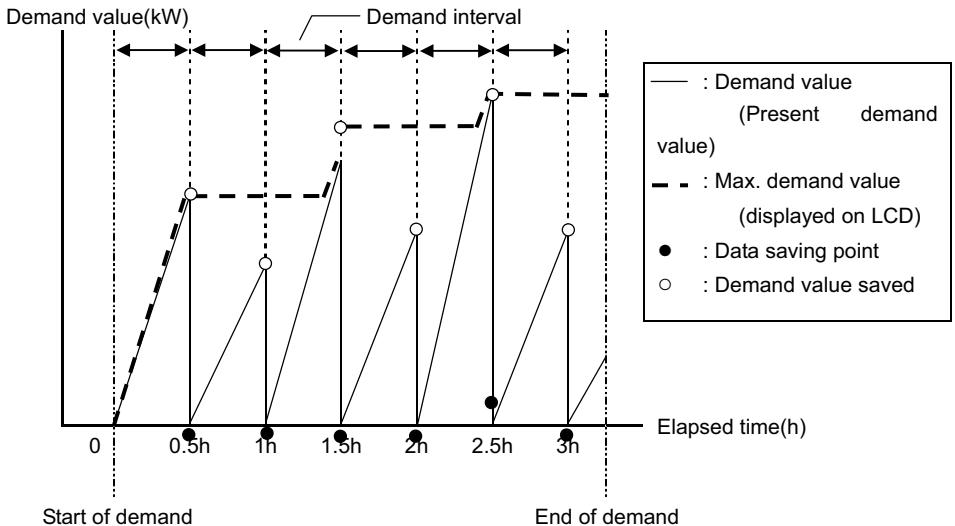



### 8-2 Changing displayed items

There are 3 display screens on **DEMAND** range, and the screens are common to each wiring configuration.

- Screens can be changed with **Cursor** keys as follows.

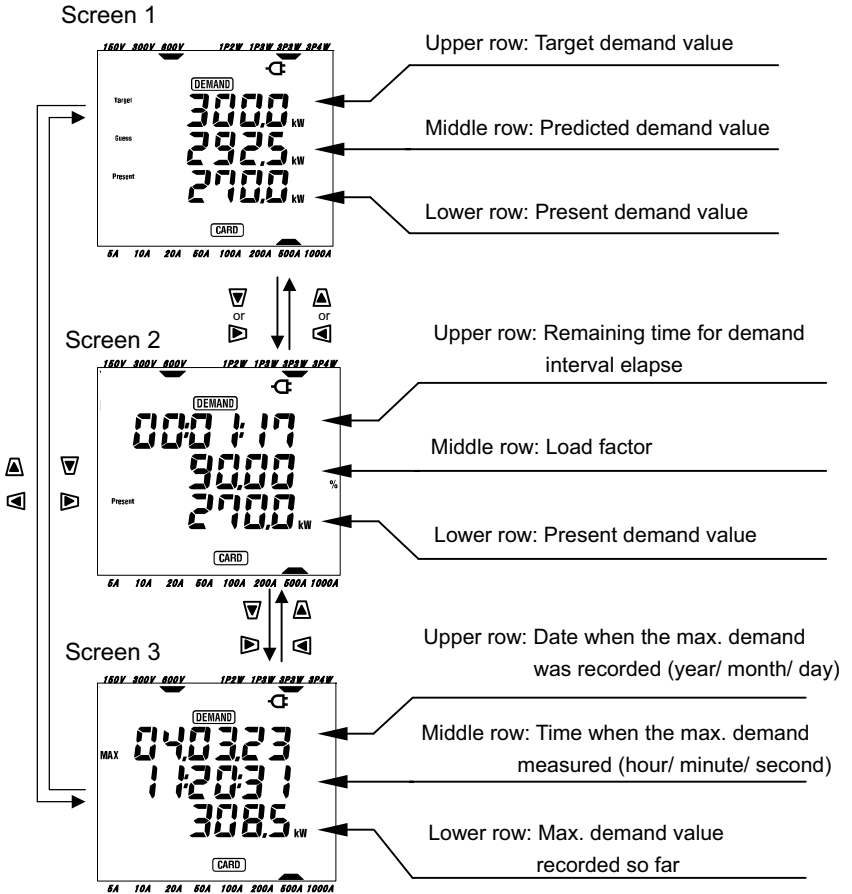

- Displayed items

<Screen 1, Upper row: Target demand value (W) >

**Target**

It is set at "**Setting 16**". Set the desired value.

<Screen 1, Middle row: Predicted demand value (W) >

**Guess**

This is the Predicted demand Value (see definitions). It is displayed on the LCD screen at the start of a survey. At the end of an interval the Predicted and Present demand value are the same. I did not understand this part!

<Screen 1, Lower row & Screen 2, Lower row: Present demand value (W) >

**Present**

This is the Present Demand Value(see definitions)

<Screen 2, Upper row: Remaining time>

This is the count down, in 1 sec. decrements to the end of the interval.

<Screen 2, Middle row: Load factor (%) >

This is the load factor(See definitions)

<Screen 3, Upper row & Middle row: Date and time >

**MAX**

These are the time and when the max. demand recorded so far from the start of the survey was measured.

<Screen 3, Lower row: Max. demand value (W) >

**MAX**

The max. demand value measured between the beginning and the end of measurement is displayed.

### 8-3 Survey initiation

There are two methods to start a survey.

(1) Manual operation

Pressing the **START/STOP** key on **DEMAND** range for at least 2 sec. starts measurement.

(2) Automatic operation (preset time and date)

Set the start time and date on **SET UP** range (“**Setting 14**”), and then press the **START/STOP** key on **DEMAND** range. The instrument goes into stand-by mode, and the measurement starts at the preset time and date.

- To start measurement manually

- \* Press the **START/STOP** key on **DEMAND** range at least 2 sec.

- \* File number screen is displayed for about 2 sec. (a file is opened), and then the measurement screen is displayed. After that, measurement starts.

At this time, LED status indicator is on. In addition, **DEMAND** and **CARD** (\*\*)  
marks appear on the measurement screen.

(\*\*) When CF card is present. When data is saved to the internal memory, **MEM** mark appears. (See “**Setting19**”).

File number screen  
(displayed for about 2 sec.)



Measurement screen

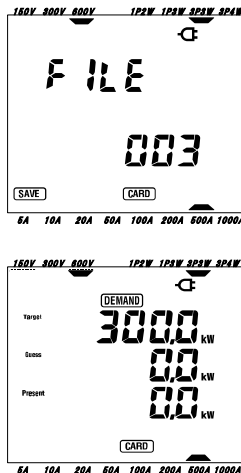

LED status indicator  
is on

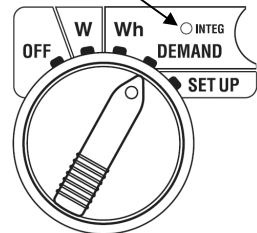

- To start measurement automatically at the preset time and date
- \* Set the start time and date on **SET UP** range (“Setting 14”).
- \* Then set the Function switch to **DEMAND** range, and press the **START/STOP** key.
- \* File number screen is displayed for about 2 sec. (a file is opened), followed by the measurement screen. The instrument goes into stand-by mode for measurement. LED status indicator and **DEMAND** mark flicker while the instrument is in stand-by mode.

File number screen  
(displayed for about 2 sec.)

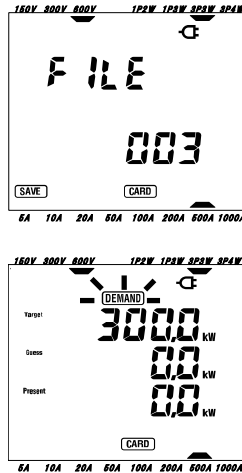

Measurement screen

LED status indicator  
flicker

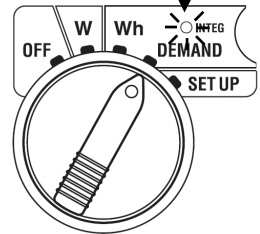

When data is saved to the CF card, **CARD** mark;  
when data is saved to the internal memory, **MEM** mark :  
appears on the File number screen and measurement screen.  
(See “Setting19”.)

- \* Measurement starts at the preset time and date, and the **DEMAND** mark and the LED status indicator stop flickering and remain on for the duration of the survey.

#### NOTE

- \* The **DEMAND** mark , which indicates demand measurement or stand-by mode, is also displayed if the Function switch is changed to **W** range or **Wh** range.

**NOTE**

- \* The start time and date should be set after the current time in such a way to give enough time to the user to complete all settings before the survey starts.
- \* When the start time and date are set before the current time, measurement starts immediately upon pressing the **START/STOP** key.
- \* When the preset start time and date come after the preset stop time and date, measurement stops right after the start of measurement.
- \* Even if the start and stop time have been preset and the instrument is in standby mode, pressing the **START/STOP** key at least 2 sec. will release the stand-by mode and start a survey in Manual mode. This renders the start/ stop time and date settings ineffective.

Then **DEMAND**, **CARD** (or **MEM**) marks disappear and the LED status indicator goes off.

## 8-4 Survey closure

There are two methods for closing a survey.

### (1) Manual operation

Pressing **START/STOP** key on **DEMAND** range for at least 2 sec. stops measurement. This action also stops the measurement started automatically at a preset date and time.

### (2) Automatic operation (specifying the time and date)

Preset the stop time and date on **SET UP** range ("Setting 15").

- To stop measurement manually
  - \* Pressing **START/STOP** key on **DEMAND** range for at least 2 sec. stops the measurement. When it stops, **DEMAND**, **CARD** (in case data is to be saved to CF card) marks disappear and the LED status indicator goes off.
- To stop measurement automatically at the preset time and date
  - Set the stop time and date on **SET UP** range. ("Setting 15")
  - This method is available only when the measurement is started at the preset time and date. When the preset stop time and date has been reached, **DEMAND**, **CARD** (in case data to be saved to CF card) marks disappear and LED status indicator goes off. The survey is then closed.

When measurement stops manually or automatically, **FILE** mark appears for 1 sec. thus closing the file opened at the start of the survey.

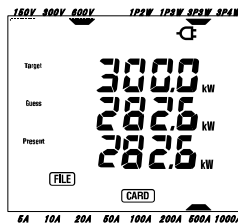

### NOTE

- \* When data is saved to the internal memory, **MEM** mark stays on even after survey closure. (indicating that a file exists in the internal memory.)

**NOTE**

- \* Turning off the instrument ( by setting the Function switch to OFF position) will stop the survey, however the measured data may be lost. It is recommended that a survey be stopped manually (**START/STOP** key) or by presetting the stop time and date.
- \* Manually starting a survey renders a preset stop time and date ineffective. The survey has to be closed manually in this case.
- \* If the survey duration is shorter than the demand interval (“**Setting 13**”) the measured data will not be saved.
- \* If the preset start time and date come after the preset stop time and date, the survey cannot be done.
- \* Pressing the **START/STOP** key at least 2 sec. releases the stand-by mode. Then **DEMAND** , **CARD** (or **MEM** ) marks disappear and the LED status indicator goes off.

## 8-5 Resetting the demand value

There are three methods for resetting (deleting) the current demand values on the display screen.

- \* Press **ESC** key on **DEMAND** range at least 2 sec. Then a message “oFF” (meaning not reset) flickers. Select “on” (reset) with the **Cursor** key, and press the **ENTER** key. The previous measured demand value will be reset, and the integration value on **Wh** range will be reset as well.

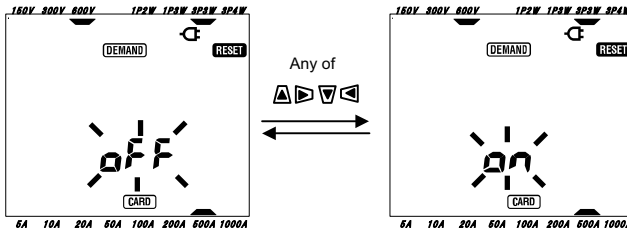

If the the **ENTER** or **ESC** key are pressed while “oFF” is flickering, the no rest is performed.

- \* Reset the demand value at “**Setting 18**”.
- \* System reset

### NOTE

- \* If it is desired to retain the integration value, start demand measurement without resetting the demand values. The items on **DEMAND** range other than the max. demand value and corresponding time and date, are reset automatically.
- \* Demand value cannot be reset during a measurement or while the instrument is in stand-by mode.



## 8-6 Saving data

When integration or demand measurement starts, the measured data will be saved automatically.

There are two locations where data can be saved.

\* **CF card** : **Max. 20 files can be saved.**

\* **Internal memory** : **Only 1 file can be saved**

Data is saved to a CF card automatically when a CF card has been inserted before turning on the instrument. If the CF card has not been inserted, data is saved automatically to the internal memory

### 8-6-1 Saving procedure

\* When a survey is started (manually or automatically) a file is opened

\* Data is saved at the end of each integration interval ("**Setting 13**").

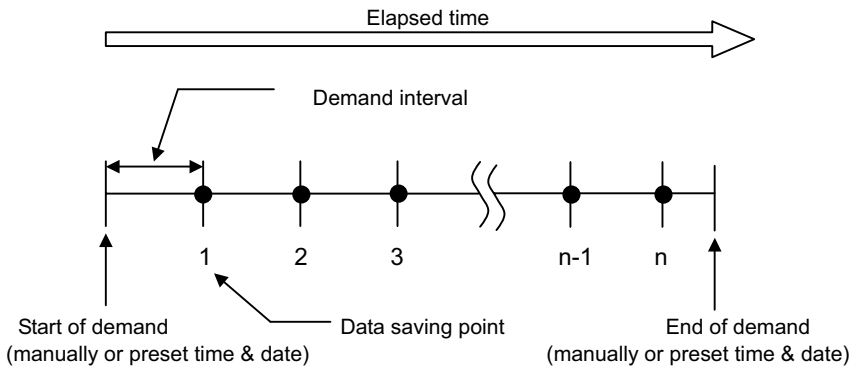

\* When the survey is closed (manually or automatically) the file is closed

\* All the recorded parameters at each data saving point are saved to one file.

### NOTE

\* Never set the Function switch to OFF position during a survey otherwise the measured data may be lost.

\* In the following cases, the file number becomes "001":

(1) when the file number has exceeded 999;

(2) after system reset

\* Data can also be saved to the internal memory even though a card has been inserted. Refer to "**Setting 19**" in this manual.

### 8-6-2 Limitation of saving

- Limitation of saving (before starting a survey)

In the following cases, a survey cannot be started (manually or automatically) by pressing the **START/STOP** key.

< In case data is saved to CF card >

- \* When 20 files have been saved to the CF card; **FULL** mark appears and further data cannot be saved.

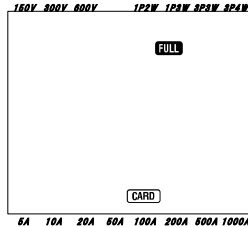

Some files can to be deleted via the PC, otherwise all the saved files in the CF card can be deleted using “**Setting 21**” of Section 4 in this manual.

< In case the data is saved to internal memory >

When previous saved data exists

- \* **MEM** mark is displayed on the LCD to indicate that there is a file in the internal memory.

Pressing the **START/STOP** key displays a screen prompting the user delete the file already saved in the internal memory.

To delete the file;

- \* The message “**dAtA not .dEL**” (not delete) is displayed on the screen. Press the **Cursor** key and select “**dAtA.dEL**” (delete).

- \* Then press the **ENTER** key.

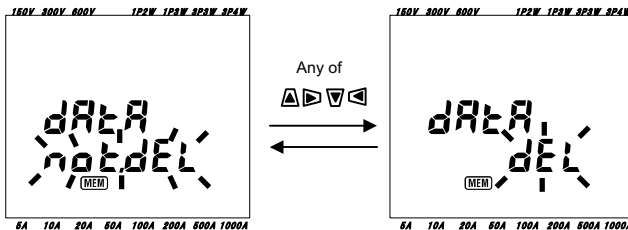

For manual operation, the survey starts upon deleting the data in the internal memory. When start time and date have been preset, the instrument goes into stand-by mode.

- Limitations of saving (during a survey)

When the capacity of CF card or internal memory has been exceeded during a survey; measurement continues but **FULL** mark appears on the display screen and further data will not be saved.

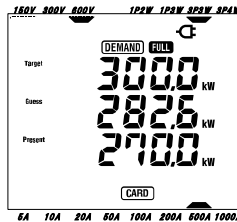

Press the **START/STOP** key 2 sec. or more and stop the survey once. Refer to preceding page and delete the unnecessary file.

#### NOTE

- \* If the function switch is set to OFF before the closure of a survey, the measured data may be lost.
- \* For further details about the capacity of the CF card and internal memory, refer to “**Section 9: CF card/ Internal memory**” in this manual.

**8-6-3 Parameters recorded**

Parameters recorded(measured or computed)	
Voltage (RMS)	Vi : Instantaneous value of phase i at end of interval
	Vi max : Max. value of phase i during interval
	Vi avg : Average value of phase i during interval
Current (RMS)	Ai : Inst value of phase i at end of interval
	Ai max : Max. value of phase i during interval
	Ai avg : Average value of phase i during interval
Active power	P : Inst value of total active power at end of interval
	P max : Max. value of P during interval
	P avg : Average value of P during interval
	Pi : Instantaneous value of phase i at end of interval
	Pi max : Max. value of phase i during interval
	Pi avg : Average value of phase i during interval
Skipped (See "7-5 Saving data" in this manual for further details.)	
Apparent electrical energy (regenerating)	-WS : Total apparent electrical energy (regenerating) during interval
	-WSi : Apparent electrical energy per phase (regenerating) during interval
Apparent electrical energy (overall)	#WS : Total apparent electrical energy(overall) during interval
	#WSi : Apparent electrical energy per phase (overall) during interval
Reactive electrical energy (consumption)	+WQ : Total reactive electrical energy (consumption) during interval
	+Wqi : Reactive electrical energy per phase (consumption) during interval

● Demand measurement:

Demand value	#DEM : Total demand value	#DEMi : Demand value of each phase
	TARGET : Target demand value	

\* i = 1, 2, 3

\* max, avg mean max value and average value during an interval.

● File format and name

Measured data is saved in CSV format, and the file name is assigned automatically.

File name: **3 FILE 001 . CSV**

- 1: Instantaneous value measurement
  - 2: Integration measurement
  - 3: Demand measurement
- FILE : CF card  
DATA : Internal memory
- File number (001 ~ 999)

● Example of measured data

Wiring:	3P3W	← Wiring	"Setting 01"
Volt Range:	600V	← Voltage range	"Setting 02"
Current Range:	500A	← Current range	"Setting 03"
Sensor Type:	500A	← Clamp sensor	"Setting 04"
VT ratio:	1	← VT ratio	"Setting 05"
CT ratio:	1	← CT ratio	"Setting 06"
Interval	30min	← Demand interval	"Setting 13"
START	2004/03/23_08:30:00	← Demand start time & date	

	DATE	TIME	ELAPSED TIME	V1	V2	V3	Q3	f	In
1	2004/03/23	09:00:00	00000:30:00						
2	2004/03/23	09:30:00	00001:00:00						
n									

V1	V2	V3	Q3	F	In	V1	V2	V3	Q3	F	In
max	max	max	max	max	max	avg	avg	avg	avg	avg	avg

+	+	+	-	#	#	#	#	+	#	#	TARGET
WP	WP1	WP2	WP3	WP	WP1	WP2	WP3	WS	DEM2	DEM3	

Data will be displayed in index format.(e.g. 110.5kW, "1.105E+5".)

## 8-7 Displayed Digits/ Over-range indication

\* Digits

\* Predicted demand value (Guess), Present demand value (Present):  
max 6 digits

The digits of the predicted and present demand values are corresponding to the target demand values listed in the table below.

Target demand value ("Setting 16")	Digit and decimal point
0.1 ~ 999.9 W	99999.9 W
0.1 ~ 999.9 kW	99999.9 kW
0.1 ~ 999.9 MW	99999.9 MW
0.1 ~ 999.9 GW	99999.9 GW

\* **Load factor (%)**:max 6 digits 9999.99%

● Over-range indication/ others

When the predicted demand value, present demand value(max demand value) and load factor exceed 99999.9, segment becomes " **OL** ".

\* When the input voltage and the current exceeds the max display counts, **V<sub>OL</sub>** or **A<sub>OL</sub>** mark is displayed on the LCD. In this case, accurate measurement cannot be made.

\* On the **W** range, when the P (active power) is shown by bars " - - - ", this means that the increment in electric energy is insignificant.

\* Refer to "6-5-2 Over-range indication/ Bar indication" in this manual.

## 9. CF card/ Internal memory

Following explains about CF card and the Internal memory.

### 9-1 Instrument and CF card/ Internal memory

Measured data can be saved in CF card and the internal memory of the instrument.

- CF card

\* Available capacity

32M/ 64M/ 128MB (CF card with more or less capacity cannot be used.)

\* Slot type

Type I/ II

\* Format

FAT16

\* CF card (operation check has completed)

Supplier	Model	Capacity
SanDisk Corporation	SDCFB-32	32MB
	SDCFB-64	64MB
	SDCFB-128	128MB
Renesas Technology Corporation	HB28B128C8C	128MB
Adtec co., Ltd.	AD-CFG32	32MB
	AD-CFG64	64MB
	AD-CFG128	128MB
BUFFALO Inc.	RCF-X32MY	32MB
	RCF-X64MY	64MB
	RCF-X128MY	128MB

\* Company name and model name are the trademark or the registered trademark.

\* A Compact Flash Card (CF card) may not operate properly even if any of the above are used due to manufacture's specification change, etc. The use of supplied

CF Card or optional Kyoritsu CF Card is recommended.

\* Max. number of files can be saved in the instrument:

20 files

- Internal memory

\* Memory type

EEPROM

\* Storage capacity

128kB

- \* Max. number of files can be saved in this instrument:  
1 file
- \* Data communication method  
USB communication  
(See “**Section 10: Communication/ Supplied software**” in this manual.”)

- Max number of data (reference)

Data saved in:		CF card			Internal memory
Capacity		32MB	64MB	128MB	128kB
Instantaneous measurement		100,000 data	200,000 data	400,000 data	1,000 data
Integration/ demand measurement interval	1sec	7 hours	14 hours	28 hours	4 minutes
	1min	18 days	36 days	72 days	4 hours
	30min	1 year or more			5 days

\* In case that no file exist in the CF card.

**NOTE**

- \* Be sure to verify proper operation of CF card on a well-known hardware.
- \* As to the manipulation of the CF card, please refer to the instruction manual attached to the card.
- \* The available recoding period varies depending on each interval.
- \* In order to save the data without any problem, make sure to delete the file other than the data measured with this instrument in the CF card.



## 9-2 Placing / removing the CF card

### DANGER

- Never open the CF card connector cover during a measurement.

### WARNING

- When placing or removing the CF card, be sure to remove the Voltage test leads and Clamp sensor from the instrument and set the Function switch to OFF position.

### CAUTION

- Be sure to set the Function switch to OFF position before placing or removing a CF card. If a CF card is placed/removed while the instrument is on, saved data or instrument may be damaged.

- How to place:

- (1) Loosen the CF card cover-fixing screw, and open the cover.
- (2) Turn the CF card obverse side up, and firmly place it in the CF card connector. Then the Eject button is popped-out.
- (3) After inserting the card, close the CF card cover and tighten the screw.

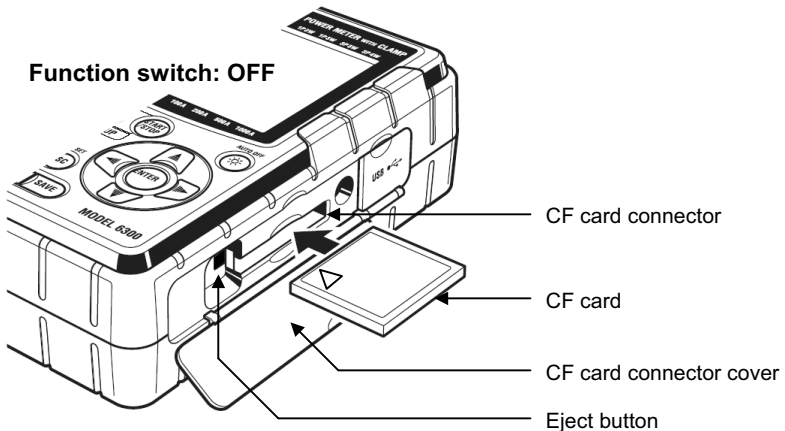

- How to remove:

- (1) Loosen the CF card cover-fixing screw, and open the cover.
- (2) The card can be removed by pushing the Eject button beside the card connector. The Eject button is being pressed down.
- (3) Remove the card, and then close the CF card cover and tighten the screw.

### NOTE

- \* When placing the CF card in the connector, pay attention to the orientation of the arrow mark indicated on the obverse side of the CF card.

### 9-3 Formatting or saving data in CF card/ Internal memory

- Formatting CF card (FAT16)

Be sure to format the CF card to be used.

<Format procedure>

- (1) Confirm that the instrument is off, and place the CF card.
- (2) Set the Function switch to **SET UP** range. (Instrument is turned on)
- (3) Follow the procedure described in “Section 4; **Setting 20**” and format the card.

- Deleting of all files

When deleting all files in the CF card and the internal memory, follow the procedure below.

\* In case of deleting all data in the CF card:

Follow the procedure described in “Section 4; **Setting 21**” and delete the data.

\* In case of deleting all data in the internal memory:

Follow the procedure described in “Section 4; **Setting 22**” and delete the data.

- Saving data

Measured instantaneous, integration and demand values can be saved to the CF card or the internal memory in CSV format, which can be edited on spreadsheet software. File number is given automatically.

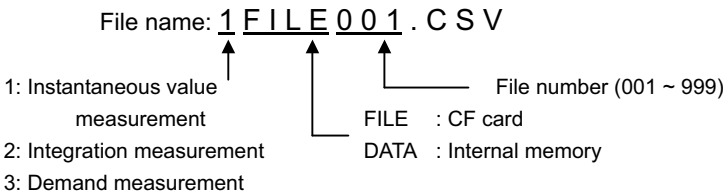

For further details, please refer to; “**6-4 Saving data**” for instantaneous value, “**7-5 Saving data**” for integration value and “**8-6 Saving data**” for demand value.

#### NOTE

- \* Instrument automatically identifies a CF card when it is turned on.
- \* When a card is inserted, data can be saved in the internal memory. Please refer to “**Setting 19**”.

## 10. Communication function/ Interface software

- Interface

This instrument is equipped with USB interface.

Communication method: USB Ver1.1

Followings can be done by USB communication:

- \* Downloading a file in the internal memory of the instrument to PC

- \* Making settings of the items on **SET UP** range via PC.

- Software

KEW POWER PLUS 2 (supplied CD-ROM)

- System requirements

- \* OS (Operation system)

Windows 98/ Me/ 2000/ XP (CPU: Pentium II 200MHz or higher)

- \* Memory

64Mbyte or more

- \* Display

Resolution 800 x 600 dots, 65536 colors or more

- \* Hard-disk space required

100Mbyte or more

- Trademark

- \* Windows<sup>®</sup> and Microsoft<sup>®</sup> Excel are the registered trademark of Microsoft in the United States.

- \* Pentium is a registered trademark of Intel in the United States.

## 10-1 Software Installation (KEW POWER PLUS 2)

- (1) Followings shall be checked before installing “KEW POWER PLUS 2”.
  - \* To prepare your system to install this software, please close all open programs.
  - \* Be sure NOT to connect the instrument with USB until install is completed.
  - \* On Windows2000/ XP, install shall be done with administrative right.
- (2) Insert the CD “KEW POWER PLUS” in your PC's CD-ROM drive. Then, KEW POWER PLUS installer sets up automatically. When it doesn't run automatically, double click the "setup\_j.exe".

Then, following window appears. Click “Next”.



- (3) Read through and understand the License Agreement, and check “I accept....”. Then click “Next”.



- (4) Enter the user information and specify the location to where install the software. Then click “Next”.

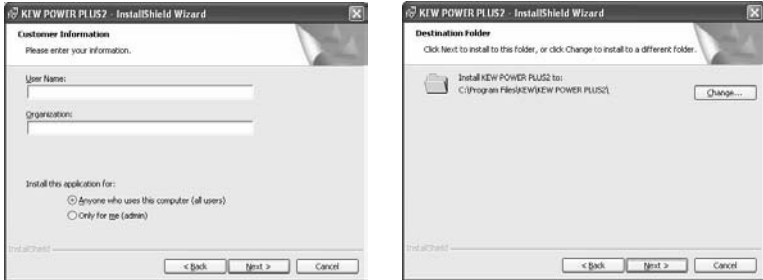

- (5) Confirm the information on install, and click “Install” to start installing.

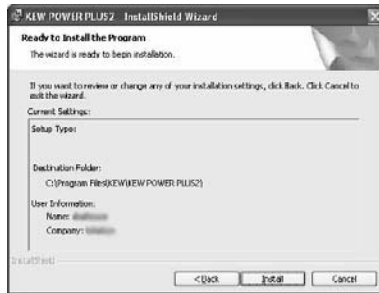

- (6) Click “Finish” when install completes.



## NOTE

- \* If you need to remove “KEW POWER PLUS”, use the “Add/Remove Programs” tool in Control Panel.

## 10-2 USB driver installation

- (1) Connect one end of a USB cord to your PC.
- (2) Set the Function switch on the instrument to **SET UP** range and connect the other end of USB cord to the instrument.

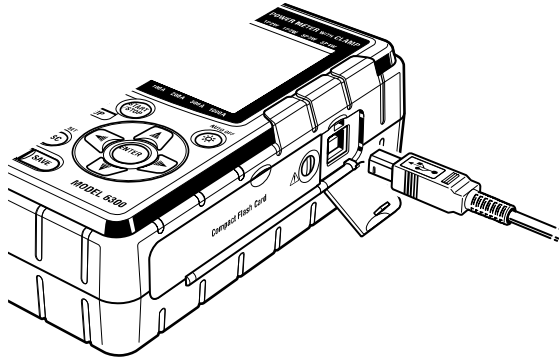

- (3) When your PC and the instrument are connected properly, install starts.

In case that following window appears on Windows XP, click “Continue anyway”. (It is an operation check, and no problem happens if install is continued.)



### NOTE

- \* When install of the driver is interrupted and reinstall cannot be done, or when install cannot be done properly, refer to “**10-7 USB driver un-installation**” in this manual.

- (4) Click “Install the software automatically (recommended)”, and insert the “KEW POWER PLUS 2” in your PC's CD-ROM drive. Then Click “Next”.



- \* When a device driver is not found automatically, click “kew\_power.inf” of KEW LOG Soft, which is in the CD-ROM drive.

- (5) Install is completed when the wizard finishes. Click “Finish”.



### 10-3 Starting “KEW POWER PLUS 2”

- Start and quit

Start the software by; 1) clicking the icon for “KEW POWER PLUS 2” on the desktop, or 2) clicking “Start” → “Program” → “KEW” → “KEW POWER PLUS 2”. Then the main window for “KEW POWER PLUS 2” appears. Click “Download” or “Setup”. Clicking “Exit” or “x” box at the upper right of the window quits the program.

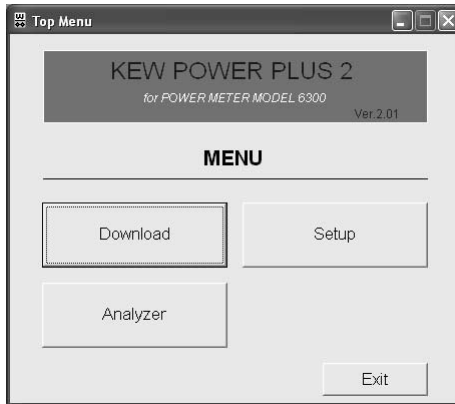

- “**Download**”: downloads the file to the internal memory of the instrument.

When data has recorded in the internal memory of the instrument, it can be saved to PC in CSV format. The saved data can be loaded in Microsoft<sup>®</sup> Excel, and be edited and printed.

(CSV format : is a comma-separated text data, and can be loaded in Microsoft<sup>®</sup> Excel.)

- “**Setup**”: makes setting for instrument.

Can make settings for the items on **SET UP** range and confirm the present settings on your PC. Moreover, settings can be saved/ recalled as a “configuration file (.kps)”. So the settings can be changed easily via PC.

\* When using this instrument for the first time, time should be set.

- **Data analysis**

Analyzes measurement data (csv format data).

Please refer to KEW PQA PLUS 2 HELP that exists in desktop.



## 10-4 Connecting the instrument to the PC

Confirm that the Function switch on the instrument is set to **SET UP** range and the instrument and your PC are connected with USB. Clicking “Download” or “Setup” displays Detection window.

< When instrument is detected properly >

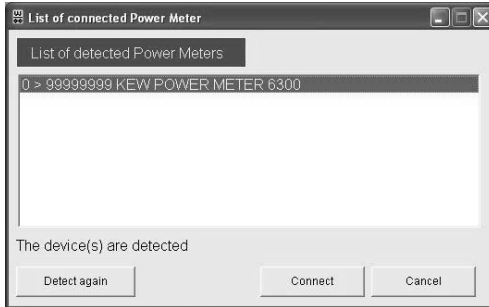

< When no instrument is detected >

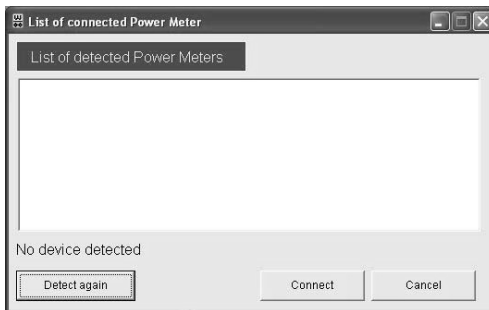

When the instrument is detected properly, click “Connect”. Then Download or Setup window appears.

If the instrument is not detected, remove and connect the USB cord, and then click “Detect again”. There is other possibility that the install of USB driver has not completed properly. Refer to “**10-7 USB driver un-installation**” in this manual and reinstall the USB driver.

## 10-5 Download to PC

- (1) Connect the instrument and your PC with a USB cord, and set the Function switch to **SET UP** range.
- (2) Start “KEW POWER PLUS 2”, and click “Download” on the Main window.
- (3) Select the instrument displayed on the “List of detected Power Meters”. Then click “Connect”.
- (4) When the instrument and your PC are connected properly, Download window appears. When error message appears, check whether USB cord is connected properly; or the instrument is on and the Function switch is set to **SET UP** range or not.

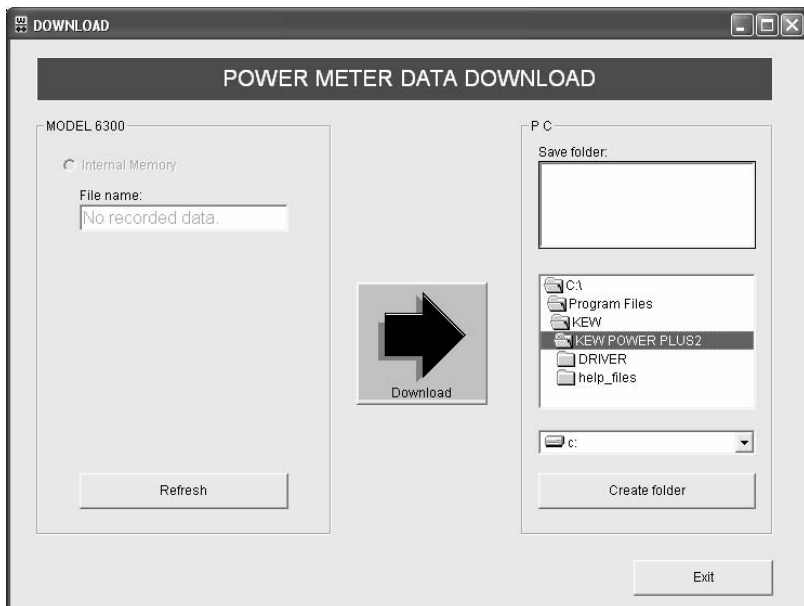

(5) Click “Refresh”.

When data exists in the internal memory of the instrument, the file name will be displayed in the box for File name. In case that no data exists, file name is not displayed and download cannot be done. First, save data with this instrument, then do downloading.

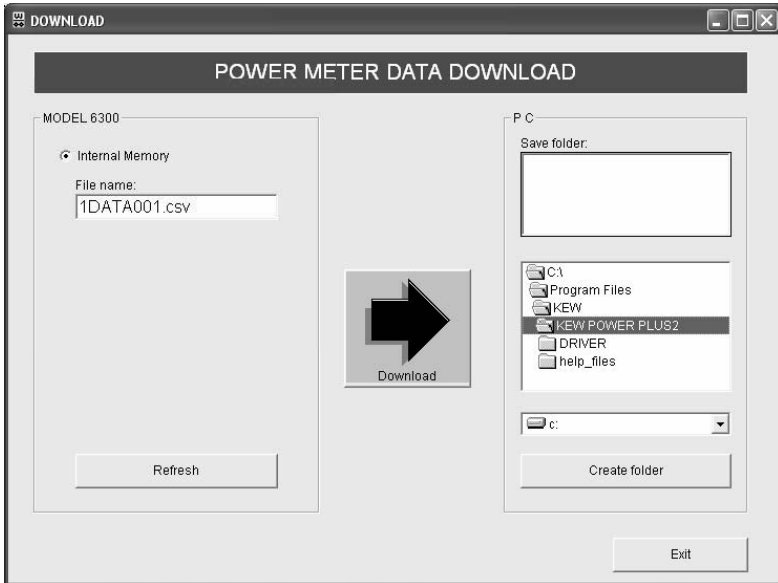

(6) Specify the folder to which download the data.

(7) Check the file name and the folder in which download the data, and then click “Download”. Then data transmission starts.

(8) When bar graph reaches the right edge, it means download completes. The saved data can be edited on the software like Excel, and be printed out.

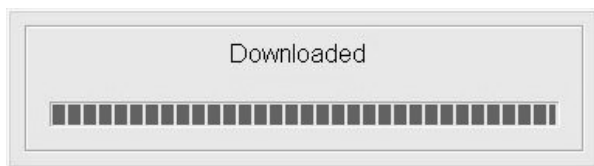

## 10-6 Set up via PC

- (1) Connect the instrument and your PC with a USB cord, and set the Function switch to **SET UP** range.
- (2) Start “KEW POWER PLUS 2”, and click “Setup” on the Main window.
- (3) Select the instrument displayed on the “List of detected Power Meters”. Then click “Connect”.
- (4) The window for “MODEL6300 POWER METER SETUP” appears. When error message appears, check whether USB cord is connected properly; or the instrument is on and the Function switch is set to **SET UP** range or not.

**MODEL 6300 POWER METER SETUP**

**General**

Wiring: 3-phase 3-wire(3P3W)

V-range: 300V

A-range: 200A

Sensor: Type 500A(50 to 500A)

VT ratio: 1

CT ratio: 1.00

Buzzer: ON

Card: ON

**Time of integration**

Start: 07/03/2007 16 : 57 : 00

End: 03/02/2004 17 : 27 : 00

Interval: 30min.

**Demand measurement**

Start: 07/03/2007 16 : 57 : 00

End: 03/02/2004 17 : 27 : 00

Interval: 30min.

Target value: 100.0 kW

Cycle: 10min.

#### (5) Buttons

##### “Send”

Can transfer the SET UP items for the instrument, which have been set on your PC, to the instrument. Settings should be made according to each use environment. After making necessary settings, click this button. Then the settings will be reflected on the **SET UP** range of the instrument.

##### “Confirm”

Can check the SET UP items for the instrument. Clicking this button loads and displays the SET UP items for the instrument. The set values before loading are overwritten. Be sure to save the important settings prior to load other settings.

##### “Initial value”

Restores all settings to the initial value. As to the initial value, refer to “**Section 4: Settings**” in this manual.

##### “Set Date/Time from PC”

Adjusts the time of the instrument to the time on your PC. Can set time and date (hour & minute are settable) by clicking this button. Adjust the time on your PC to the present time first.

##### “Save”

Can save the settings as configuration file. (\*.kps)  
Setting corresponding to each environment can be saved.  
If the configuration file is saved together with the recorded data, record/measurement conditions can be checked as well.

##### “Configuration file”

Opens the saved configuration files. (\*.kps)  
If the settings corresponding to an environment have been saved, you can switch the setting to the proper one immediately.  
If the configuration file is saved as conditions for record/measurement, settings at that time can be checked as well.

##### “Exit”

Closes the setting screen.

#### NOTE

- \* For further details about each setting items, refer to “**Section 4: Setting**” in this manual.

## 10-7 USB driver un-installation

When install of the USB driver is interrupted and reinstall cannot be done, follow the procedure below and delete the existing USB driver. Then install it again.

- (1) Connect a PC and the instrument with a USB cord.
- (2) Click “Control Panel” in the Start menu at the lower left on the Windows screen.
- (3) Click “System” in the control panel.
- (4) Then click “Device Manager”.
- (5) Right click on “KEW POWER METER 6300” in the “Universal Serial Bus controllers”.
- (6) Click “Uninstall” and uninstall the USB driver.

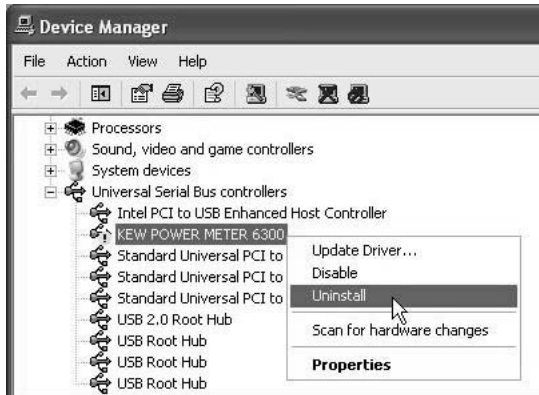

- (7) Remove the USB cord connecting your PC and the instrument once, and connect them again.
- (8) When “Found New Hardware Wizard” window appears, follow the procedure described at “**10-2 USB driver installation**” and install the driver.

## 11. Other functions

- Time (clock)

This instrument has clock function, and the time is set to Japan time by default. On **SET UP** range, time/date information can be viewed or changed. Refer to “Setting 07” in section 4 in this manual.

- Backlight

Pressing the **BACKLIGHT** key (  ) switches on/off the backlight for LCD. The backlight is automatically switched off when it remains on for about 5min.

- Data hold

The indicated value on the LCD is held by pressing the **DATAHOLD** key (  ), and “**H**” mark appears on the LCD.

At this point, the instrument is performing calculation and data save.

Data hold function works on each range as follows.

“Available” : Pressing the **DATAHOLD** key holds the indicated value.

The values on each measurement are also held.

“Invalid” : Data hold function doesn’t operate even if the **DATAHOLD** key is pressed.

Status	Data hold function on each range			
	<b>W</b> range	<b>Wh</b> range	<b>DEMAND</b> range	<b>SET UP</b> range
Measuring instantaneous value	<b>Available</b>	<b>Invalid</b>		
Stand-by for integration	<b>Invalid</b>			
Measuring integration value	<b>Available</b>		<b>Invalid</b>	
Stand-by for demand	<b>Invalid</b>			
Measuring demand value	<b>Available</b>			<b>Invalid</b>



Data hold function is released and “**H**” mark disappears by pressing the **DATAHOLD** key again. This function can be released on any range.

### NOTE

\* Keys are locked by pressing the **DATAHOLD** key at least 2 sec. either Data hold function is on or off. If both Data hold and Key lock functions are enabled at the same time, Data hold function cannot be released until the Key lock function is released.

\* When the Function switch is set to OFF, both functions are released.

- Key lock

Pressing the **DATAHOLD** key (  ) at least 2 sec. locks the keys. The “” mark appears on the LCD. Then all keys other than Function switch and **BACKLIGHT** key are disabled. Pressing the **DATAHOLD** key at least 2 sec. again releases the Key lock function. Then the “” mark disappears.

#### NOTE

- \* Pressing the **DATAHOLD** key at least 2 sec. activates Data hold function.
- \* If both Data hold and Key lock functions are enabled at the same time, Data hold function cannot be released until the Key lock function is released.
- \* When the Function switch is set to OFF, both functions are released.

- System reset

Settings on each range changes after system reset as follows.

Range	After system reset
<b>W</b> range	Customized parameters return to the initial value.
<b>Wh</b> range	Previous integration value displayed on the LCD is reset.
<b>DEMAND</b> range	Previous demand value displayed on the LCD is reset.
<b>SET UP</b> range	Each setting parameters returns to the initial value.(*)
Others	* A file in the internal memory is deleted. * When saving data, file number for CF Card or internal memory becomes 001. (If the same file name exists, the old one will be overwritten.)

\* Some settings don't return to the initial value.

For further details, refer to “**4-1 List of setting items**” in this manual.

System reset can be done in either of following two methods.

- (1) Follow the procedure described at “**Setting 23**” on **SET UP** range.

Refer to “**4-3-23 System reset**” in this manual.

- (2) Press the **ESC** key (  ) and operate the Function switch.  
Rotate the Function switch from OFF to any other range while the **ESC** key is being pressed down. The **ESC** key shall be kept pressed down until the setting or measurement screen for the selected range appears.

Now, system reset completes.



## 12. Troubleshooting

### 12-1 General Trouble-shooting

When defect or breakdown of the instrument is suspected, check the following points first. If your problem isn't listed in this section, contact your local Kyoritsu distributor.

Symptom	Check
1. No indication when the Function switch is set to other than OFF.	<ul style="list-style-type: none"> <li>* Confirm that;               <ol style="list-style-type: none"> <li>1) the Power cord is connected to the outlet properly.</li> <li>2) there is no break in the Power cord.</li> <li>3) supply voltage is within the allowable range.</li> </ol> </li> </ul>
2. Error code appears when turning on the instrument.	<ul style="list-style-type: none"> <li>* Error code below appears when turning on the instrument.  <b>Err001 ~ Err063</b>                Internal circuit may be damaged. Contact you local Kyoritsu distributor.</li> </ul>
3. Any key doesn't work	<ul style="list-style-type: none"> <li>* Check if key lock function "  " is activated or not.</li> <li>* Confirm the available keys on each range</li> </ul>
4. Error code appears while making setting.	<ul style="list-style-type: none"> <li>* Error message appears in the following cases  <b>SEtErr</b></li> <li>* If the settings on Voltage range ("<b>Setting 02</b>"), Current range ("<b>Setting 03</b>"), VT ratio ("<b>Setting 05</b>") and CT ratio ("<b>Setting 06</b>") are as indicated below, this error code appears. Setting should be made again.  <math>(\text{Voltage range}) \times 120\% \times (\text{Current range}) \times 120\% \times (\text{VT ratio}) \times (\text{CT ratio}) &gt; 9999G \quad (G=10^9)</math></li> <li>* If the day that does not exist has been set as integration start time and date ("<b>Setting 10</b>") or as demand start time and date ("<b>Setting 14</b>").</li> </ul>
5. Indicated values are not stable, or not correct.	<ul style="list-style-type: none"> <li>Confirm that:               <ul style="list-style-type: none"> <li>* voltage test leads and clamp sensors are connected properly.</li> <li>* setting and wiring on the instrument against the line under test are appropriate.</li> <li>* there is no break in the voltage test leads.</li> <li>* input signal is not interfered.</li> <li>* strong electric magnetic field does not exist in close proximity.</li> <li>* environment meets the specification of this instrument.</li> </ul> </li> </ul>

<p>6. Data cannot be saved in the CF card</p>	<ul style="list-style-type: none"> <li>* Confirm that the instrument recognizes the CF card. (“<b>Setting 19</b>”).</li> <li>* Check the max number of file or capacity of CF card to be used.</li> <li>* Confirm that the operation of CF card to be used is checked.</li> <li>* Verify the proper operation of CF card on other hardware.</li> <li>* Format the CF card. (“<b>Setting 20</b>”)</li> </ul>
<p>7. Saved file in the CF card doesn't contain the measured data.</p>	<p>In following cases, measured data won't be recorded in files.</p> <ul style="list-style-type: none"> <li>* File wasn't closed (set the Function switch to any position other than OFF and <b>W</b> range) after instantaneous value is saved by pressing the <b>SAVE</b> key on the <b>W</b> range. (see “<b>6-4 Saving data</b>”)</li> <li>* The period from the beginning to the end of integration/demand measurement is shorter than the interval.</li> <li>* Set the Function switch to OFF position before integration/ demand measurement ends.</li> </ul>
<p>8. Download and setting cannot be done via USB communication.</p>	<p>Confirm that:</p> <ul style="list-style-type: none"> <li>* the instrument and your PC are connected with USB cord correctly.</li> <li>* the Function switch is at <b>SET UP</b> range.</li> </ul>

## 12-2 Battery replacement

When the battery mark displayed on the LCD becomes “”, batteries are almost exhausted.

### DANGER

- Never open the Battery cover during a measurement.

### WARNING

- Remove Power cord, Voltage test leads and Clamp sensors from the instrument and set the Function switch to OFF position before replacing the batteries.

### CAUTION

- Do not mix new and old batteries.
- Install batteries in correct polarity as marked inside.

- Battery
  - Alkaline size AA battery
  - LR6 (1.5V) x 6pcs
- How to replace batteries
  - (1) Loosen two Battery cover-fixing screws, and remove the Battery cover.
  - (2) Install new batteries in correct polarity as marked inside.
  - (3) Then put the Battery cover and tighten up the screws.

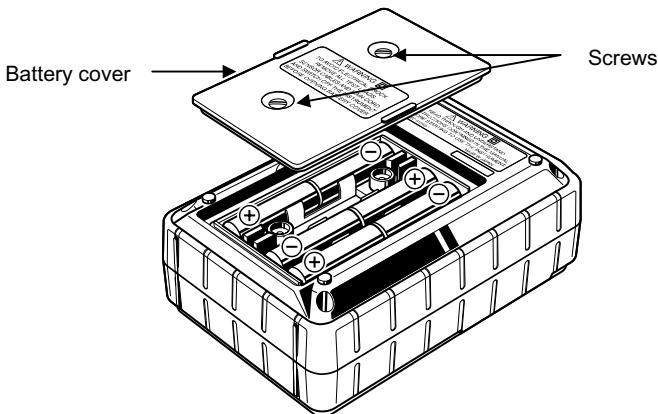

## 13. Specification

### 13-1 General specification

Location for use	In door use, Altitude up to 2000m
Temperature&humidity Range (guaranteed accuracy)	23°C±5°C/Relative humidity 85% or less (no condensation)
Operating temperature & humidity range	0°C~50°C/Relative humidity 85% or less (no condensation)
Storage temperature & humidity range	-20°C~60°C/Relative humidity 85% or less (no condensation)
Measured line	single-phase 2-wire (1ch ~ 3ch), single-phase 3-wire, three-phase 3-wire, three-phase 4-wire
Withstand voltage	AC5320V/ for 5 sec. between (voltage input terminal) and (enclosures) AC3320V/ for 5 sec. between (voltage input terminal) and (power supply, USB connector) AC2710V/ for 5 sec. between (power connector) and (USB connector, current input terminal, enclosures)
Insulation resistance	50MΩ or more / 1000V between (voltage/ current input terminal, power connector) and (enclosures)
Display	Liquid crystal display (segment type)
Indication renewal	every 1 sec.
Backlight	Pressing the backlight key switches the light on/off. (Light is automatically turned off after 5 minute.)
Rated AC power supply voltage	100V ~ 240V ± 10% (45~65Hz) 10VA max.
Rated DC power supply voltage	9V (Alkaline size AA battery (LR6) 1.5V x 6pcs) Current consumption 180mA typ. (7 hours continuous measurement/ at LR6 is used)
Applicable standard	IEC 61010-1 Measurement CAT. III 600V, Pollution degree 2 IEC 61010-031, IEC 61326
Dimension	175(L) x 120 (W) x 65 (D) mm
Weight	approx. 800g (including batteries)

Accessories	<p>Voltage test leads MODEL7141 x 1set (red/ green/ black/ blue, 1pce for each)</p> <p>Power cord MODEL7170 x 1pce</p> <p>USB cord MODEL7148 x 1pce</p> <p>Alkaline size AA battery (LR6) x 6pcs</p> <p>Compact flash card 32MB</p> <p>Card Reader MODEL8319 x 1pce</p> <p>CD-ROM x 1pce</p> <p>Communication soft ware (KEW POWER PLUS)</p> <p>Instruction manual (PDF file)</p> <p>Quick manual x 1pce</p> <p>Carrying Case MODEL9125 x 1pce</p>
Optional	<p>MODEL8124 (Clamp sensor 1000A type)</p> <p>MODEL8125 (Clamp sensor 500A type)</p> <p>MODEL8126 (Clamp sensor 200A type)</p> <p>MODEL8127 (Clamp sensor 100A type)</p> <p>MODEL8128 (Clamp sensor 50A type)</p>

## 13-2 Instantaneous value measurement

### (1) Voltage $V_i$ [V]

Range	150/ 300/ 600V
Displayed digit	4 digits
Allowable input	10 ~ 110% of each range
Display range	5 ~ 120% of each range
Crest factor	2.5 or less
Accuracy	$\pm 0.3\% \text{rdg} \pm 0.2\% \text{f.s.}$ (sine wave 45 ~ 65Hz)
Instantaneous overload	720V (for 10 sec.)
Input impedance	Approx. 2.7M $\Omega$

### (2) Current $A_i$ [A]

Range	50A type :5/ 10/ 20/ 50A ( 500mV / 50A = 10mV / A ) 100A type :10/ 20/ 50/ 100A ( 500mV / 100A = 5mV / A ) 200A type :20/ 50/ 100/ 200A ( 500mV / 200A = 2.5mV / A ) 500A type :50/ 100/ 200/ 500A ( 500mV / 500A = 1mV / A ) 1000A type :100/ 200/ 500/ 1000A ( 500mV / 1000A = 0.5mV / A ) 3000A type :1000/ 3000A (3000A: CT=3.00) ( 500mV / 1000A,3000A = 0.5mV, 0.167mV / A )
Displayed digit	4 digits
Allowable input	10 ~ 110% of each range
Display range	1 ~ 120% of each range
Crest factor	3.0 or less (each range: 90% or less)
Accuracy	$\pm 0.3\% \text{rdg} \pm 0.2\% \text{f.s.}$ + accuracy of clamp sensor (sine wave: 45 ~ 65Hz)
Instantaneous overload	120% of the rated current of each clamp sensor (for 10 sec.)
Input impedance	Approx. 100k $\Omega$

### (3) Active power $P_i$ [W]

Range	(Voltage range) x (Current range)
Displayed digit	4 digits
Accuracy	$\pm 0.5\% \text{rdg} \pm 0.2\% \text{f.s.}$ + accuracy of clamp sensor (power factor: 1, sine wave: 45 ~ 65Hz)
Effect of power factor	$\pm 1.0\% \text{rdg}$ (indicated value: power factor 0.5 against power factor 1)
Polarity indication	Consumption : + (no mark), Regeneration: -

### (4) Frequency $f$ [Hz]

Measuring range	40.0 ~ 70.0Hz
Displayed digit	3 digits
Allowable input	10 ~ 110% of each voltage range (sine wave 45 ~ 65Hz)
Accuracy	$\pm 3 \text{dgt}$
Input source	Detect from V1 (voltage between voltage input terminals: VN and V1)

## (5) Calculation items and equations

Item	Wiring	Equation	
Active power	1P2W (1ch)	$P = P1$	
	1P2W (2ch)	$P = P1 + P2$	
	1P2W (3ch)	$P = P1 + P2 + P3$	
	1P3W	$P = P1 + P2$	
	3P3W	$P = P1 + P2$	
	3P4W	$P = P1 + P2 + P3$	
Apparent power	1P2W (1ch)	$S = V \times A$	
	1P2W (2ch)	$S_i = V \times A_i \quad (i=1,2)$	$S = S1 + S2$
	1P2W (3ch)	$S_i = V \times A_i \quad (i=1,2,3)$	$S = S1 + S2 + S3$
	1P3W	$S_i = V_i \times A_i \quad (i=1,2)$	$S = S1 + S2$
	3P3W	$S_i = V_i \times A_i \quad (i=1,2)$	$S = \sqrt{3}/2 (S1 + S2)$
	3P4W	$S_i = V_i \times A_i \quad (i=1,2,3)$	$S = S1 + S2 + S3$
Reactive power (*1, *2)	1P2W (1ch)	$Q = \sqrt{S^2 - P^2}$	
	1P2W (2ch)	$Q_i = \sqrt{S_i^2 - P_i^2} \quad (i=1,2)$	$Q = Q1 + Q2$
	1P2W (3ch)	$Q_i = \sqrt{S_i^2 - P_i^2} \quad (i=1,2,3)$	$Q = Q1 + Q2 + Q3$
	1P3W	$Q_i = \sqrt{S_i^2 - P_i^2} \quad (i=1,2)$	$Q = Q1 + Q2$
	3P3W	$Q_i = \sqrt{S_i^2 - P_i^2} \quad (i=1,2)$	$Q = Q1 + Q2$
	3P4W	$Q_i = \sqrt{S_i^2 - P_i^2} \quad (i=1,2,3)$	$Q = Q1 + Q2 + Q3$
Power factor (*1)	1P2W (1ch)	$PF = \left  \frac{P}{S} \right $	
	1P2W (2ch)	$PF_i = \left  \frac{P_i}{S_i} \right  \quad (i=1,2)$	$PF = \left  \frac{P}{S} \right $
	1P2W (3ch)	$PF_i = \left  \frac{P_i}{S_i} \right  \quad (i=1,2,3)$	$PF = \left  \frac{P}{S} \right $
	1P3W	$PF_i = \left  \frac{P_i}{S_i} \right  \quad (i=1,2)$	$PF = \left  \frac{P}{S} \right $
	3P3W	$PF_i = \left  \frac{P_i}{S_i} \right  \quad (i=1,2)$	$PF = \left  \frac{P}{S} \right $
	3P4W	$PF_i = \left  \frac{P_i}{S_i} \right  \quad (i=1,2,3)$	$PF = \left  \frac{P}{S} \right $
Neutral current (*3)	$I_n = \sqrt{\{A1 + A2 \cos(\theta2 - \theta1) + A3 \cos(\theta3 - \theta1)\}^2 + \{A2 \sin(\theta2 - \theta1) + A3 \sin(\theta3 - \theta1)\}^2}$ <p style="text-align: center;">* <math>\theta1, \theta2, \theta3</math> : phase difference of A1, A2, A3 against V1</p>		

\* 1: The plus/minus sign is displayed by multiplying the polarity obtained based on varmeter method.

+ (no polarity): Delay phase (inductivity), - : Advance phase (capacitive)

\* 2: For distorted or unbalance wave inputs, there may be discrepancies between this instrument and others that operate based on different measurement principals.

\* 3: Can be measured only at making settings for 3P4W (three-phase 4-wire).

**13-3 Integration value measurement**

(1) Active electric energy WP [Wh]

Displayed item	Consumption(Total: $+WP$ , each phase: $+WP_i$ ) * Regeneration and overall: Data is saved only.	
Display range	0.00Wh ~ 999999GWh (digit and unit is adjusted to $+WS$ )	
Displayed digit	6 digits (decimal position, unit is adjusted to $+WS$ )	
Equation	Consumption ( $+WP$ )	Each phase: $+WP_i = \sum \frac{(+P_i)}{h}$ , Total: $+WP = \sum (+WP_i)$
	Regeneration ( $-WP$ )	Each phase: $-WP_i = \sum \frac{(-P_i)}{h}$ , Total: $-WP = \sum (-WP_i)$
	Overall ( $\Sigma WP$ )	Each phase: $\Sigma WP_i = (+WP_i) + (-WP_i)$ Total: $\Sigma WP = \sum (\Sigma WP_i)$

\* Consumption (+Pi) : when P>0, Regeneration(-Pi) : when P<0 \*  $h$  : time of integration  
 \*  $i=1$  : 1P2W (1ch),  $i=1,2$  : 1P2W(2ch)/ 1P3W/ 3P3W,  $i=1,2,3$  : 1P2W(3ch)/3P4W

(2) Apparent electric energy WS [VAh]

Displayed item	Consumption(Total: $+WS$ , each phase: $+WS_i$ ) * Regeneration and overall: Data is saved only.	
Display range	0.00VAh ~ 999999GVAh (digit and unit is adjusted to $+WS$ )	
Displayed digit	6 digits (decimal position, unit is adjusted to $+WS$ )	
Equation	Consumption ( $+WS$ )	Each phase: $+WS_i = \sum \frac{(+S_i)}{h}$ , Total: $+WS = \sum (+WS_i)$
	Regeneration ( $-WS$ )	Each phase: $-WS_i = \sum \frac{(-S_i)}{h}$ , Total: $-WS = \sum (-WS_i)$
	Overall ( $\Sigma WS$ )	Each phase: $\Sigma WS_i = (+WS_i) + (-WS_i)$ , Total: $\Sigma WS = \sum (\Sigma WS_i)$

\* Consumption (+Si) : when P>0, Regeneration(-Pi) : when P<0 \*  $h$  : time of integration  
 \*  $i=1$  : 1P2W (1ch),  $i=1,2$  : 1P2W(2ch)/ 1P3W/ 3P3W,  $i=1,2,3$  : 1P2W(3ch)/3P4W

(3) Reactive electric energy WQ [Varh]

Displayed item	Nothing (Consumption: Data is saved.)	
Equation	Consumption ( $+WQ$ )	$+WQ = \sqrt{(+WS)^2 - (+WP)^2}$

(4) Time of integration

Displayed item	00:00:00 (hour: minute: second) *varies depending on elapsed time	
Display range	→ 00:00:00 ~ 99:59:59 (99-hour 59-min 59-sec)	
	→ 0100:00 ~ 9999:59 (9999-hour 59-min)	
	→ 010000 ~ 999999 (999999-hour)	

(5) Setting item

Record interval	1/ 2/ 5/ 10/ 15/ 20/ 30sec. 1/ 2/ 5/ 10/ 15/ 20/ 30min. 1 hour
Start/ Stop	By manual operation or specifying start/ stop date and time

\* Record interval = Integration interval



### 13-4 Demand value measurement

#### (1) Target value ( $T_{DEM}$ )

Display range	0.1W ~ 999.9GW (set value is fixed)
---------------	-------------------------------------

#### (2) Predicted value ( $G_{DEM}$ )

Display range	0 ~ 999999dgt * Decimal position, unit is same to $T_{DEM}$ .
Equation	$G_{DEM} = \Sigma DEM \times \frac{\text{Demand interval}}{\text{Period from beginning of demand interval}}$

#### (3) Demand value (present value) ( $\Sigma DEM$ )

Display range	0 ~ 999999dgt * Decimal position, unit is same to $T_{DEM}$ .
Equation	$\Sigma DEM = \left( + WP \text{ from beginning of demand interval} \right) \times \frac{1 \text{ hour}}{\text{Demand interval}}$ $\Sigma DEM = \sum \Sigma DEM_i$

\*  $i = 1$  : 1P2W(1ch)

\*  $i = 1,2$  : 1P2W(2ch), 1P3W, 3P3W

\*  $i = 1,2,3$  : 1P2W(3ch), 3P4W

#### (4) Load factor

Display range	0.00 ~ 9999.99%
Equation	$\frac{\Sigma DEM}{T_{DEM}}$

#### (5) Setting item

Record interval (Demand interval)	1/ 2/ 5/ 10/ 15/ 20/ 30sec. 1/ 2/ 5/ 10/ 15/ 20/ 30min. 1 hour
Start/ Stop	By manual operation or specifying start/ stop date and time
Demand target value	0.1W ~ 999.9GW
Inspection cycle	Can select one of three preceding time to the set record interval. (e.g. When interval is 30min., select one from 10/ 15/ 20min. when interval is 5min., select one from 30sec/ 1/ 2min. * In case that the record interval is set to one of 1/ 2/ 5sec., setting for inspection cycle is not available. * When $G_{DEM} > T_{DEM}$ is detected at each inspection cycle, buzzer sounds and backlight blinks.

### 13-5 Other specifications

#### (1) Communication function

Communication method	USB Ver1.1
Communication speed	19200bps

\* Connecting some MODEL6300 (max. 10pcs) in daisy chain via HUB enables individual identification. (Data transmission to PC shall be done one by one.)

\* Recommended length of USB cord is 2m or less.

#### (2) CF card interface

Slots	Type I/ II
Compatibility	32/ 64 /128MB
Format	FAT16
Number of files can be saved	max. 20 files
Saving format	CSV format
File name	<p>▲FILE■■■.csv</p> <p>▲: 1 (instantaneous measurement), 2 (integration measurement), 3 (Demand measurement)</p> <p>■■■ : 001~999 sequence number (given automatically) Number returns to 001 after system reset.</p>

#### (3) Internal memory

Memory type	EEPROM
Storage capacity	128kB
Number of files can be saved	1 file
File name	<p>▲DATA■■■.csv</p> <p>▲: 1 (instantaneous measurement), 2 (integration measurement), 3 (Demand measurement)</p> <p>■■■ : 001~999 sequence number (given automatically) Number returns to 001 after system reset.</p>

#### (4) Scaling function

VT ratio	1 ~ 10000 (in 1 increments)
CT ratio	1.00 ~ 10000 (in 0.01 increments)

#### (5) Other functions

- \* Time (clock)
- \* Data hold
- \* Key lock
- \* System rest

### 13-6 Specification of Clamp sensor

#### < MODEL8124 >

- Rated current  
AC 1000A rms (AC 1414A peak)
- Output voltage  
AC 0 ~ 500mV (AC 500mV/ 1000A)
- Measuring range and accuracy (sine wave input)

Measuring range	Frequency range	Accuracy
0 ~ 1000 A	50/60Hz	$\pm 1.0\%rdg \pm 0.2mV$
	40Hz ~ 1kHz	$\pm 1.5\%rdg \pm 0.4mV$

- Phase characteristic  
within  $\pm 1deg$  (10 ~ 1000A/ 45~65Hz)
- General specification

Location for use	In door use, Altitude up to 2000m
Temperature & humidity range (guaranteed accuracy)	23°C $\pm$ 5°C/Relative humidity 85% or less (no condensation)
Operating temperature & humidity range	0°C ~ 50°C/Relative humidity 85% or less (no condensation)
Storage temperature & humidity range:	-20°C ~ 60°C/Relative humidity 85% or less (no condensation)
Max allowable input	AC 1000A rms continuously (50/60Hz)
Output impedance	approx. 1 $\Omega$
Withstand voltage	AC5350V rms (50/60Hz)/ for 5sec. between jaw matched part and enclosures between enclosures and output terminal between jaw matched part and output terminal
Insulation resistance	50M $\Omega$ or more/ 1000V between jaw matched part and enclosures between enclosures and output terminal between jaw matched part and output terminal
Applicable standard	IEC 61010-2-032 Measurement CATIII. 600V, Pollution degree 2 IEC 61326
Diameter of measured conductor	Max. $\Phi$ 68mm
Cable length	About 3m
Output terminal	MINI DIN 6PIN
Outer diameter	186(L) x 129(W) x 53(D) mm
Weight	Approx. 510g
Accessories	Instruction manual, Cable maker

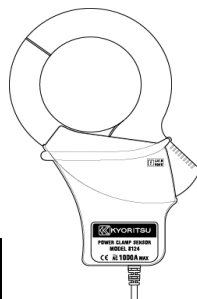

## &lt; MODEL8125 &gt;

- Rated current  
AC 500A rms (AC 707A peak)
- Output voltage  
AC 0 ~ 500mV (AC 500mV/ 500A)
- Measuring range and accuracy (sine wave input)

Measuring range	Frequency range	Accuracy
0 ~ 500 A	50/60Hz	$\pm 0.5\%rdg \pm 0.1mV$
	40Hz ~ 1kHz	$\pm 1.0\%rdg \pm 0.2mV$

- Phase characteristic  
within  $\pm 1deg$  (5 ~ 500A/ 45~65Hz)
- General specification

Location for use	In door use, Altitude up to 2000m
Temperature & humidity range (guaranteed accuracy)	23°C $\pm$ 5°C/Relative humidity 85% or less (no condensation)
Operating temperature & humidity range	0°C ~ 50°C/Relative humidity 85% or less (no condensation)
Storage temperature & humidity range:	-20°C ~ 60°C/Relative humidity 85% or less (no condensation)
Max allowable input	AC 500A rms continuously (50/60Hz)
Output impedance	approx. 2 $\Omega$
Withstand voltage	AC5350V rms (50/60Hz)/ for 5sec. between jaw matched part and enclosures between enclosures and output terminal between jaw matched part and output terminal
Insulation resistance	50M $\Omega$ or more/ 1000V between jaw matched part and enclosures between enclosures and output terminal between jaw matched part and output terminal
Applicable standard	IEC 61010-2-032 Measurement CATIII. 600V, Pollution degree 2 IEC 61326
Diameter of measured conductor	Max. $\Phi 40mm$
Cable length	About 3m
Output terminal	MINI DIN 6PIN
Outer diameter	128(L) x 81(W) x 36(D) mm
Weight	approx. 260g
Accessories	Instruction manual, Cable maker

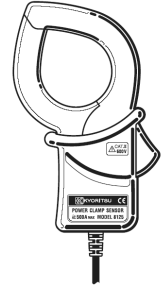

**< MODEL8126 >**

- Rated current  
AC 200A rms (AC 283A peak)
- Output voltage  
AC 0 ~ 500mV (AC 500mV/ 200A)
- Measuring range and accuracy (sine wave input)

Measuring range	Frequency range	Accuracy
0 ~ 200 A	50/60Hz	$\pm 0.5\% \text{rdg} \pm 0.1 \text{mV}$
	40Hz ~ 1kHz	$\pm 1.0\% \text{rdg} \pm 0.2 \text{mV}$

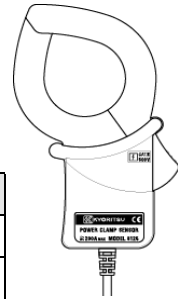

- Phase characteristic  
within  $\pm 1 \text{deg}$  (2 ~ 200A/ 45~65Hz)
- General specification

Location for use	In door use, Altitude up to 2000m
Temperature & humidity range (guaranteed accuracy)	23°C $\pm$ 5°C/Relative humidity 85% or less (no condensation)
Operating temperature & humidity range	0°C ~ 50°C/Relative humidity 85% or less (no condensation)
Storage temperature & humidity range:	-20°C ~ 60°C/Relative humidity 85% or less (no condensation)
Max allowable input	AC 200A rms continuously (50/60Hz)
Output impedance	approx. 5 $\Omega$
Withstand voltage	AC5350V rms (50/60Hz)/ for 5sec. between jaw matched part and enclosures between enclosures and output terminal between jaw matched part and output terminal
Insulation resistance	50M $\Omega$ or more/ 1000V between jaw matched part and enclosures between enclosures and output terminal between jaw matched part and output terminal
Applicable standard	IEC 61010-2-032 Measurement CATIII. 600V, Pollution degree 2 IEC 61326
Diameter of measured conductor	Max. $\Phi$ 40mm
Cable length	About 3m
Output terminal	MINI DIN 6PIN
Outer diameter	128(L) x 81(W) x 36(D) mm
Weight	approx. 260g
Accessories	Instruction manual, Cable maker

**< MODEL8127 >**

- Rated current  
AC 100A rms (AC 150A peak)
- Output voltage  
AC 0 ~ 500mV (AC 500mV/ 100A)
- Measuring range and accuracy (sine wave input)

Measuring range	Frequency range	Accuracy
0 ~ 100 A	50/60Hz	$\pm 0.5\%rdg \pm 0.1mV$
	40Hz ~ 1kHz	$\pm 1.0\%rdg \pm 0.2mV$

- Phase characteristic  
within  $\pm 2deg$  (1 ~ 100A/ 45~65Hz)
- General specification

Location for use	In door use, Altitude up to 2000m
Temperature & humidity range (guaranteed accuracy)	23°C $\pm$ 5°C/Relative humidity 85% or less (no condensation)
Operating temperature & humidity range	0°C ~ 50°C/Relative humidity 85% or less (no condensation)
Storage temperature & humidity range:	-20°C ~ 60°C/Relative humidity 85% or less (no condensation)
Max allowable input	AC 100A rms continuously (50/60Hz)
Output impedance	approx. 11 $\Omega$
Withstand voltage	AC3540V rms (50/60Hz)/ for 5sec. between jaw matched part and enclosures between enclosures and output terminal between jaw matched part and output terminal
Insulation resistance	50M $\Omega$ or more/ 1000V between jaw matched part and enclosures between enclosures and output terminal between jaw matched part and output terminal
Applicable standard	IEC 61010-2-032 Measurement CATIII. 300V, Pollution degree 2 IEC 61326
Diameter of measured conductor	Max. $\Phi 24mm$
Cable length	About 3m
Output terminal	MINI DIN 6PIN
Outer diameter	100(L) x 60(W) x 26(D) mm
Weight	Approx. 170g
Accessories	Instruction manual, Cable maker



**< MODEL8128 >**

- Rated current  
AC 50A rms (AC 70.7A peak)
- Output voltage  
AC 0 ~ 500mV (AC 500mV/ 50A)
- Measuring range and accuracy (sine wave input)

Measuring range	Frequency range	Accuracy
0 ~ 50 A	50/60Hz	$\pm 0.5\%rdg \pm 0.1mV$
	40Hz ~ 1kHz	$\pm 1.0\%rdg \pm 0.2mV$

- Phase characteristic  
within  $\pm 2deg$  (0.5 ~ 50A/ 45~65Hz)
- General specification

Location for use	In door use, Altitude up to 2000m
Temperature & humidity range (guaranteed accuracy)	23°C $\pm$ 5°C/Relative humidity 85% or less (no condensation)
Operating temperature & humidity range	0°C ~ 50°C/Relative humidity 85% or less (no condensation)
Storage temperature & humidity range:	-20°C ~ 60°C/Relative humidity 85% or less (no condensation)
Max allowable input	AC 50A rms continuously (50/60Hz)
Output impedance	approx. 19 $\Omega$
Withstand voltage	AC3540V rms (50/60Hz)/ for 5sec. between jaw matched part and enclosures between enclosures and output terminal between jaw matched part and output terminal
Insulation resistance	50M $\Omega$ or more/ 1000V between jaw matched part and enclosures between enclosures and output terminal between jaw matched part and output terminal
Applicable standard	IEC 61010-2-032 Measurement CATIII. 300V, Pollution degree 2 IEC 61326
Diameter of measured conductor	Max. $\Phi$ 24mm
Cable length	About 3m
Output terminal	MINI DIN 6PIN
Outer diameter	100(L) x 60(W) x 26(D) mm
Weight	Approx. 170g
Accessories	Instruction manual, Cable maker

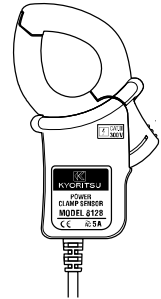

Kyoritsu reserves the rights to change specifications or designs described in this manual without notice and without obligations.



**KYORITSU ELECTRICAL  
INSTRUMENTS  
WORKS, LTD.**

No.5-20,Nakane 2-chome, Meguro-ku,  
Tokyo, 152-0031 Japan

Phone: +81-3-3723-0131

Fax: +81-3-3723-0152

URL: <http://www.kew-ltd.co.jp>

E-mail: [info@kew-ltd.co.jp](mailto:info@kew-ltd.co.jp)

Factories: Uwajima & Ehime